

# Annual Report

# Leadership that Transforms



Instituto Tecnológico  
y de Estudios Superiores  
de Monterrey



EISAC

Enseñanza  
e Investigación  
Superior, A. C.



Fundación  
Santos y De la Garza Evia

# Introduction



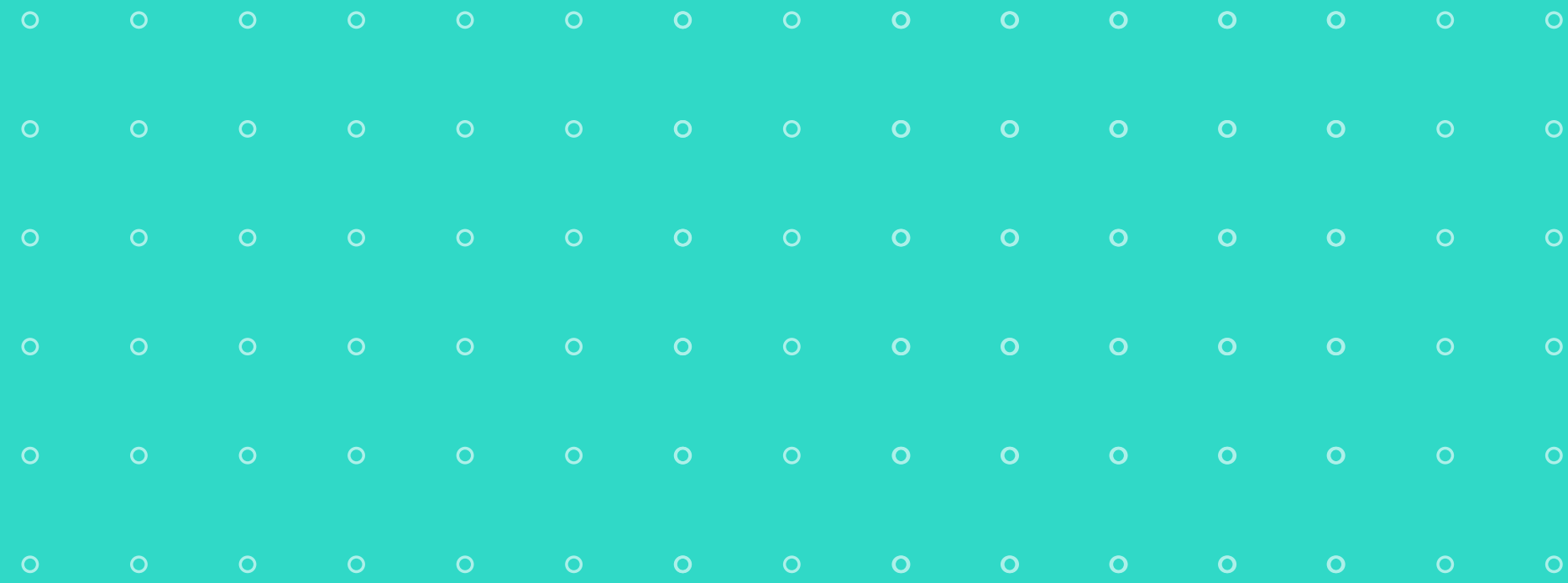

Letter from the  
President of  
Tecnológico de Monterrey

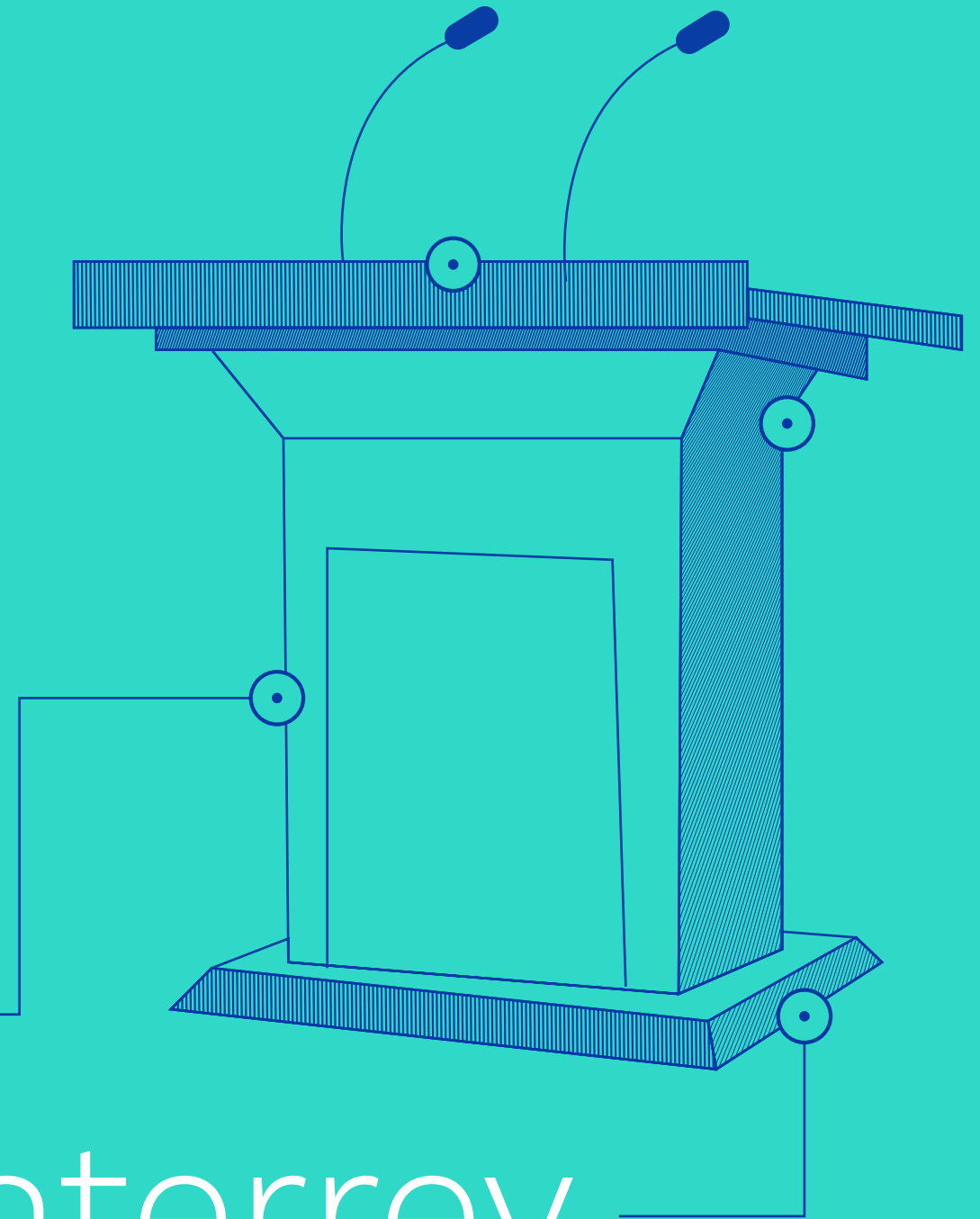

# Letter from the President of Tecnológico de Monterrey

It is a pleasure to share this report corresponding to the 2023 activities of the Instituto Tecnológico de Estudios Superiores de Monterrey (ITESM), Enseñanza e Research A. C. (EISAC), and Fundación Santos y de la Garza Evia (FSGE).

2023 was a memorable year for the achievements and advances of our Institution, characterized by celebrations of the **80th anniversary** of our foundation and **the succession of our President of the Board of Trustees**.

In February, as part of the Annual Assembly, **José Antonio Fernández Carbajal**, who was in charge for **11 years**, and will continue to accompany us as a member of said body of government, completed his term as President. We appreciate his leadership, which leaves a great legacy, highlighting the institutionalization of government bodies, an innovative educational model, distritotec, the promotion of a culture of generosity and the Leaders of Tomorrow program, to mention just a few achievements.

We welcomed **Ricardo Ernesto Saldívar Escajadillo** as **the fifth President of the Board** of Trustees of Tecnológico de Monterrey, who has played roles as President and advisor in different government bodies of the institution for **10 years** and whose outstanding career and dedication promise to continue guiding us to keep building legacies that transcend. 2023 has been key to advancing on our path towards 2025. We graduated the **first generation of Tec21**. We had

**the largest number of graduates in our history**, with more than 25 thousand new Undergraduate, Graduate and High School students that finished.

**We strengthened the talent** of the faculty. Of the more than 2,000 full-time undergraduate and graduate professors, 62% have a doctoral degree; 19% completed their graduate studies in foreign universities that are among the best 200 in the world, and 13% are of foreign origin. 10 new professors were integrated into our **Faculty of Excellence** program, now reaching a total of 26.

Our **three research institutes** continue to take their first steps on the path towards research associated with high-impact causes. In this sense, we began the evolution of the **distritotec experience towards a pole of innovation and entrepreneurship**, with events and activities where leaders and entrepreneurs from different sectors met to connect about solutions to today's challenges.

We hosted international events such as **The Times Higher Education Latin American Summit** and **The Worldwide Universities Network Annual General Meeting**, which together attracted +300 academic leaders from the five continents, including more than 25 rectors of the best universities in the world.

At **Tecmilenio** we have exceeded **62 thousand students** in formal education, the highest number in history, and we have a community of 154 thousand graduates.

At **Tecsalud**, we reaffirm our **positioning in various hospital rankings**, such as **América Economía's "The best private hospitals in Latin America"** where the Zambrano Hellion Hospital was positioned **#2 in Mexico** and **San José #3**.

Thanks to the **generosity** of our donors, we had a record of donations to reach our goals. Highlights include Fundación FEMSA, FRISA and SESAJAL among others, as well as three generous donations from EXATEC to carry out important works of academic and living infrastructure in Monterrey and Guadalajara.

In the context of our **80th anniversary**, our facilities were filled with joy and vitality with more than 45 events held on 25 campuses, achieving the participation of more than 170,000 people including students, EXATEC, professors, collaborators, board members, parents and friends of Tec.

In September we stepped in the **ninth decade** of Tecnológico de Monterrey, in the context of a world in **constant evolution**, in which a change of era is glimpsed, marked by digital transformation, particularly with the emergence of Artificial Intelligence, climate change, geopolitical aspects, demographic evolution, the revival of the space age and genomics, to name just a few.

In a world in which tomorrow is a challenge and at the same time a promise, we begin a process to define what our route will be towards 2030. Imagining what our new students will be like in the future, but with the certainty that, as in 80 years, thanks to the **dedication and passion of professors, collaborators and board members**, Tecnológico de Monterrey will continue its constant search for excellence, which commits us to building legacies that transcend, legacies that transform people, people who contribute to having a better country and a better global society.

**David Garza Salazar**  
President of Tecnológico de Monterrey







80th anniversary



# 80 Years of Leadership

Events that have marked the leadership of Tec in 80 years

+ Tec in Numbers

## 1943-1953

### First Decade – Foundation

- Laying the foundation

1943

Foundation with 350 students, Business and Engineering majors, High School and Comprehensive Education. Unique characteristics in Mexico: full-time professors, semester academic periods.

1947

Campus Monterrey, first university campus in Mexico.

1950

Accreditation of the Southern Association of Colleges and Schools (today SACSCOC), the first accredited university outside USA.



## 1953-1963

### Second Decade

- Maturing the project

1954

The Cervantina Library is born.

1958

Joins the National Association of Universities and Higher Education Institutions (ANUIES, in Spanish).

1961

Master's degrees begin.  
First formal meeting of EXATEC.



## 1963-1973

### Third Decade

- Foray into computing

1967

Guaymas, first incursion outside Monterrey .

1968

Doctoral degrees begin.

1969

Practical schools are born: immersion of students in companies.

First computer arrives and 6 years later the first Computer Science degree is launched in Mexico.



## 1973-1983

### Fourth Decade

- Geographic expansion and foray into health
- 18 Campuses, 2 Schools and 2 PrepaTec are opened

1978

School of Medicine is born, and Hospital San José becomes part of the Tec.

1978

First University in Latin America to write academic degrees for women in feminine.



# 80 Years of Leadership

Events that have marked the leadership of Tec in 80 years

If you want to know more details about the history of Tecnológico de Monterrey for decades, consult it here:



You can also access the video of the 8 decades of Tec in the following QR:



## 1983-1993

### Fifth Decade

- Faculty and Graduate Development Satellite Education
- Internet

1983

Steve Jobs awards Tec in Cupertino for the use of personal computers.

1985

Impulse to professors to obtain graduate degrees.

1988

First Internet connection in Latin America.

1989

Monterrey International Book Fair.



## 1993-2003

### Sixth Decade

- Promoting distance education
- Redesign of teaching practice
- Foray into Public Administration
- Tecmilenio

1994

First forum of candidates for the presidency of Mexico held by students from a university.

1996

Virtual University launched: distance education.

2002

Tecmilenio University is born.



## 2003-2013

### Seventh Decade

- Internationalization, Research, Ecosystem and entrepreneurship
- Creation of School of Government and Public Transformation and TecSalud
- Tecmilenio Expansion

2005

Prepanet, low-cost online baccalaureate.

2007

Promotion of internationalization generates: 48% of graduates with international experience (in 1997 it was less than 17%).

2012

TecSalud is born with the inauguration of Zambrano Hellion Hospital.



## 2013-2023

### Eighth Decade

- Innovating in the educational model, selectivity, transformation of environments and social mobility

2014

Leaders of Tomorrow 100% Scholarship Program

2014

Distritotec is launched, a community where urban transformation, quality of life and innovation are promoted.

2019

Tec21 Model is launched for all majors on all campuses.

2020

Leadership of TecSalud, Tec de Monterrey and Tecmilenio in pandemic.

2017 - 2023

Hologram professor, virtual reality, metaverse, TecGPT.



# 80th Anniversary of Tecnológico de Monterrey

The year 2023 marked a significant milestone for Tecnológico de Monterrey as it celebrated its 80th anniversary, an occasion that transcended borders and left a mark in the history of the Institution.

- More than 45 events with impact at local, national and international level.
- Participation of more than 170,000 in-person and virtual attendees.
- Positive impact on more than 41,000 EXATEC.
- Media coverage with more than 2,700 articles in national and international media.

## FEATURED EVENTS

This 80th anniversary stands as a testimony of the continued commitment of the Tecnológico de Monterrey with academic excellence, innovation and comprehensive education of professionals that contribute positively to society. A milestone that encourages us to look to the future with renewed vigor and dedication.

### ● Inspire to Transform

Cycle of talks and conferences for reflection and innovation. It had the participation of 10 speakers, including Paola Anotnelli, Tawakkol Karman, Enrique Krauze, etc. There was an audience of more than 8,700 in-person attendees and more than 6,200 virtual attendees.



### ● The Tecnológico Artistic Society returns

The Artistic Society returned more powerful, presenting notable artists such as Mezzo-soprano Isabel Leonard, María Pagés de Sheherezade, Kronos Quartet and the Don Giovanni Opera. This return highlighted the cultural and artistic wealth of the community with +2,700 attendees.

### ● Student celebration

In collaboration with FETEC and the anniversary organizing committee, we celebrate the famous annual Tec event, designed by and for students. More than 50,000 attendees, including students and collaborators, enjoyed the activities. The participation of more than 50 students in the event stood out.

### ● When the thread becomes a network: living memory of the women at Tec

The legacy of women was honored and made visible with a gender perspective vision that showed how memory is a thread of memories, actions and hopes that compose our university community. Exhibition present on 4 campuses (Monterrey, Querétaro, CDMX and Guadalajara) With more than 600 participants.

### ● Ceremony 80

We spanned the decades, reflecting on our past and achievements as a source of inspiration to build lasting legacies. The story of Don Eugenio Garza Sada highlighted the importance of believing in education and the dream of a better Mexico. This event marked the beginning of our 80th anniversary with more than 1,600 in-person attendees, 2,400 virtual, the participation of 30 students and more than 11,300 visits.

### ● “Legacy” EXATEC Ensemble Concert

It honored the musical tradition of the Institution, fostered unity and community spirit among EXATEC, students, professors, collaborators and society in general, thus celebrating the artistic and cultural legacies of Tecnológico de Monterrey. It had the participation of 53 singers, 17 musicians and 22 staff, all EXATEC. And +3,200 people attended.





# 80th Anniversary of Tecnológico de Monterrey

● **UNO Day: A noble and historic decision**

The “UNO Day” event took us back to the beginning of Tec in 1943. With the unveiling of a plaque and speeches, we honored our founders. The musical play, starring 7 students and 3 collaborators, stood out at this event that brought together more than 1,400 attendees, celebrating the essential values of Tec de Monterrey in its 80 years of history.



● **FESTUM**

FESTUM, the emblematic event of the 80th anniversary of Tecnológico de Monterrey, celebrated the significance of our Institution. The Tec community, composed of students, collaborators, EXATEC, came together to highlight 80 years of history, the mural, multiculturalism and fundamental values. More than 30,000 in-person and virtual attendees and 1,250 students representing 29 campuses and PrepaTec.



● **Sports events**

The Mexican College Football Showcase, supported by the Houston Texans, the NFL, CEMEX and Banorte, highlighted college football and promoted the sport, providing visibility to Tec teams and ONEFA rivals. In addition, the “Think Feel Run” 5 and 10K race, held on several campuses, brought together more than 2,000 participants in Monterrey, providing a space for harmony and coexistence in the celebration of the 80th anniversary.



● **Leaving a Mark Recognition**

Recognition event that the EXATEC community and Tecnológico de Monterrey extend to more than 900 professors who, thanks to their empathy and knowledge, have impacted the life, academic and professional education in a transcendent way in our students.

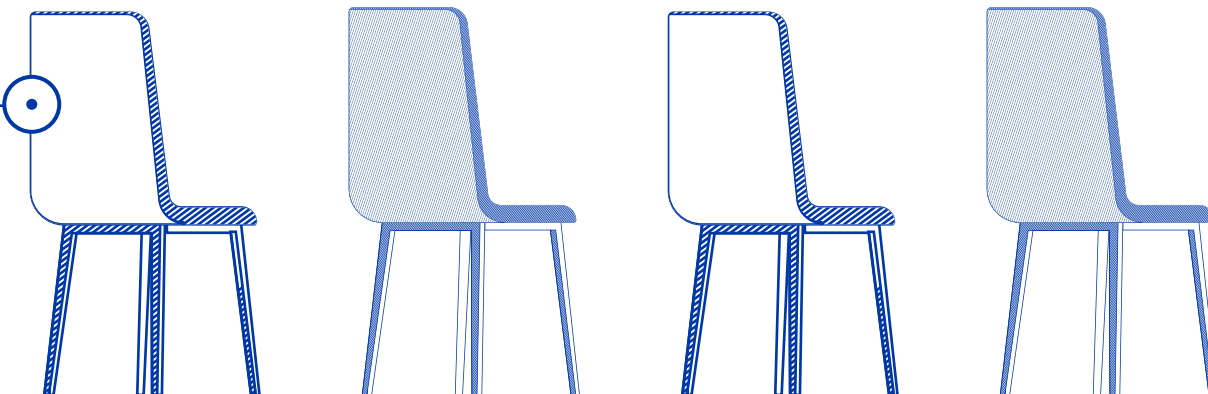

● **Sculptures to inspiring professors**

The first 6 statues were unveiled to honor the professors who have inspired and impacted the students of Tec de Monterrey.

● **In addition, other events were experienced such as:**

The Research Congress, Educational Innovation Congress, International Book Fair, Vibrart and Graduations, among others, continued to enrich the academic and cultural life of the Tec.



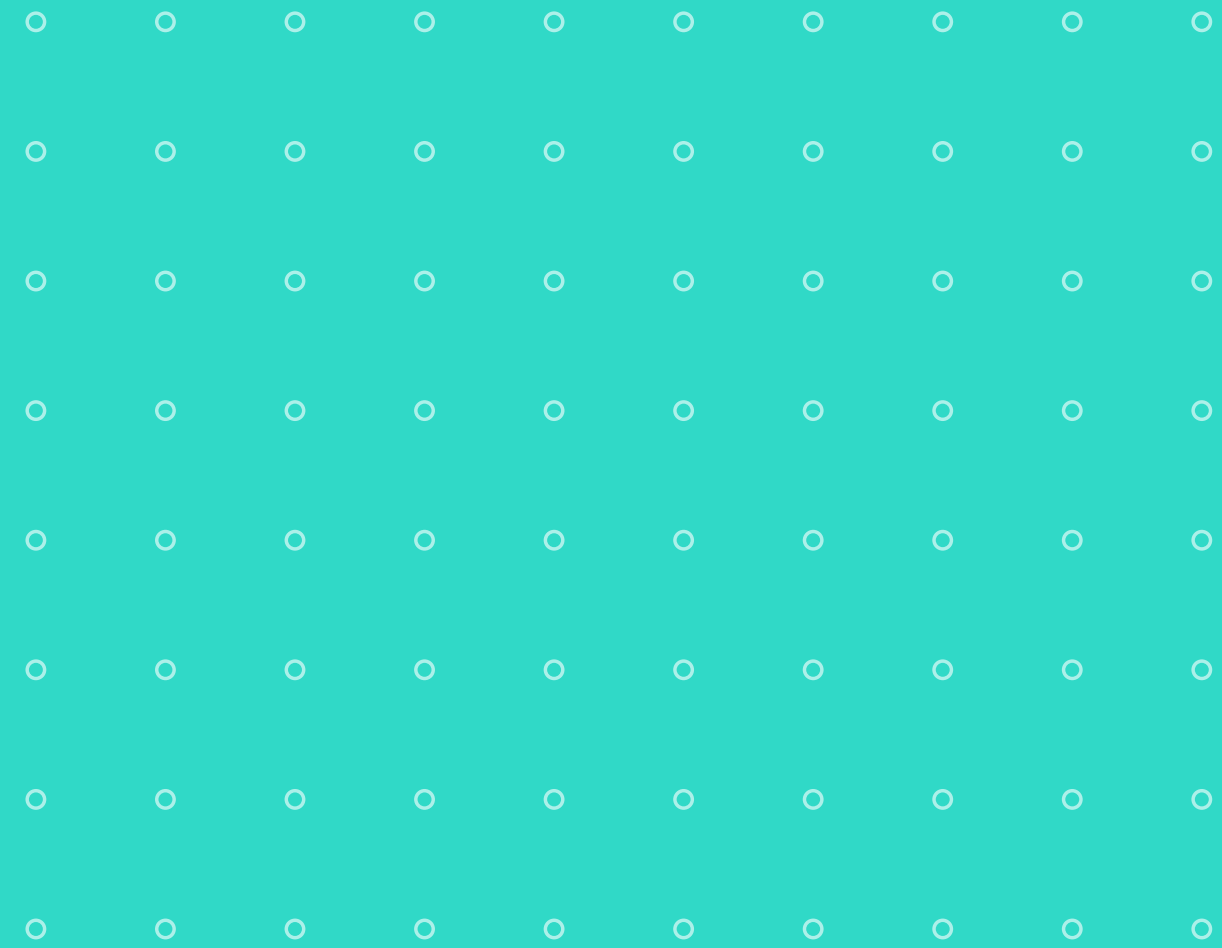

# Tec in Numbers

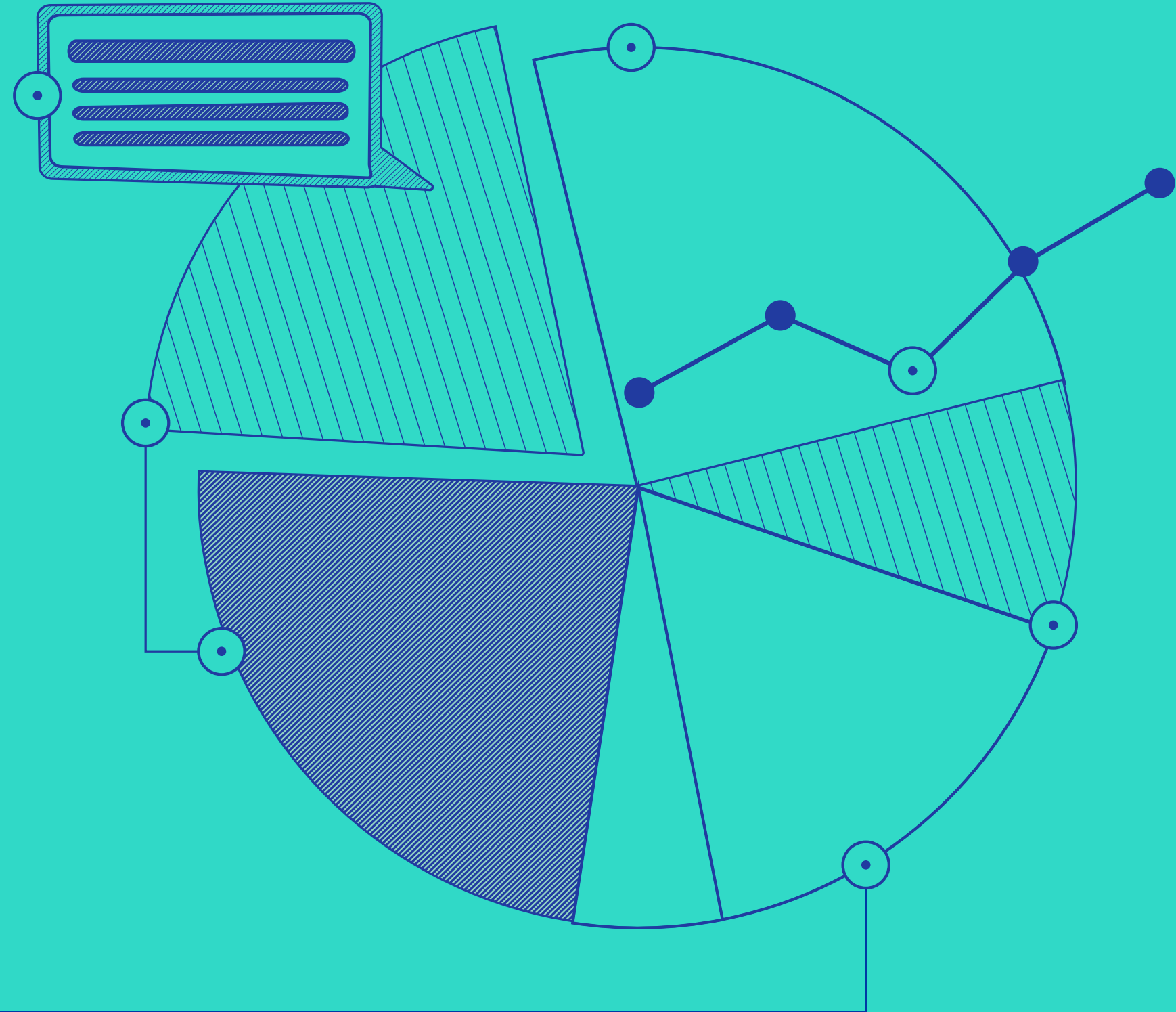

# Tec in Numbers

Tecnológico de Monterrey is a private non-profit multi-campus university system. It is formed by three institutions: Tecnológico de Monterrey, Tecmilenio and TecSalud. It was established in 1943 by a group of Mexican entrepreneurs led by Eugenio Garza Sada.

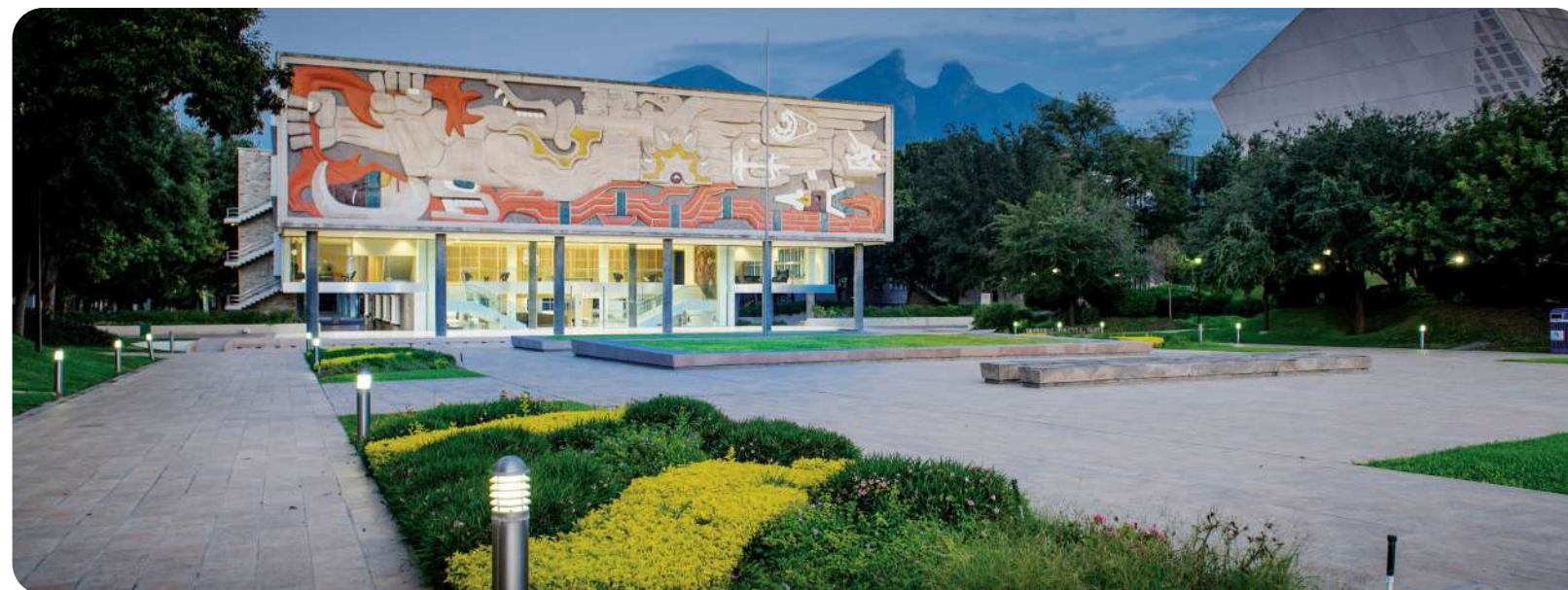

## TEC DE MONTERREY

Tec de Monterrey is a private non-profit multi-campus university system that stands out for its academic excellence, innovation in education, entrepreneurship, and internationalization as well as for its partnerships with industry and employers, in addition to its great capacity for execution, which has made the Institution a leader among the country's private universities.

It is present in 32 municipalities in 20 states of Mexico; has an enrollment of more than 89,000 high school, undergraduate and graduate students; and over 11,000 professors. The institution has been accredited by the Commission on Colleges of the Southern Association of Colleges and Schools (SACSCOC) since 1950.

It is part of several prestigious international networks such as the Association of Pacific Rim Universities (APRU), Universitas 21 (U21), and The Worldwide Universities Network (WUN), among others.

## TECMILENIO

Established in 2002, Tecmilenio is present in 27 cities around Mexico and has over 62,000 students enrolled in various academic degrees, plus a Skilling Center that offers continuing education to over 52,000 learners. It focuses on comprehensive wellbeing and offers high-quality education, designed for its students to achieve their goals and discover their Life Purpose. The academic plan is co-created with companies and experts, with the aim of our students acquiring technical and human skills, which results in high employability. It has more than 167 thousand graduates to date.

## TECSALUD

TecSalud is our Academic Health System that integrates innovative clinical, educational and research services. It is comprised of: two Academic Medical Centers - Hospital San José and Hospital Zambrano Hellion-, the Speciality Institutes and the Fundación TecSalud. The TecSalud Academic Medical Centers are where students from the Tec de Monterrey School of Medicine and Health Sciences carry out clinical and training activities.

# TEC DE MONTERREY

## Students

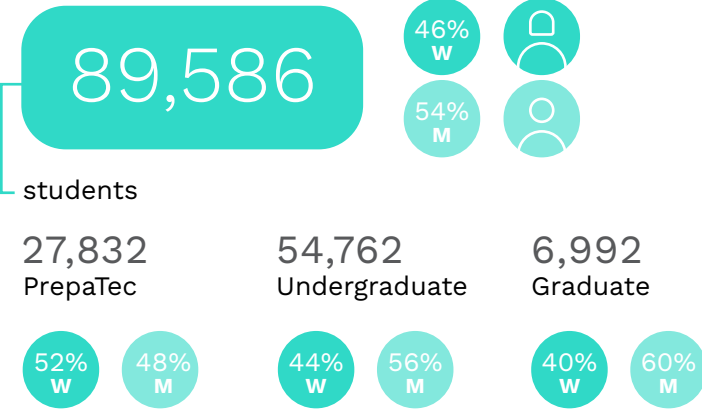

## Professors

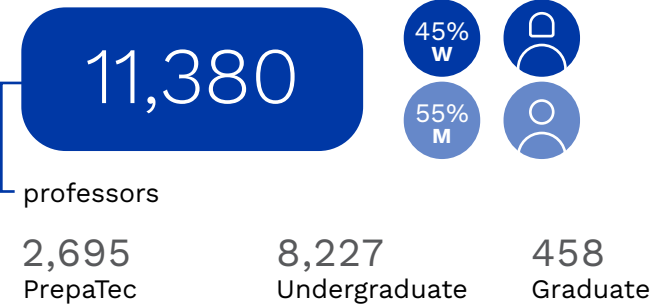

## Employees

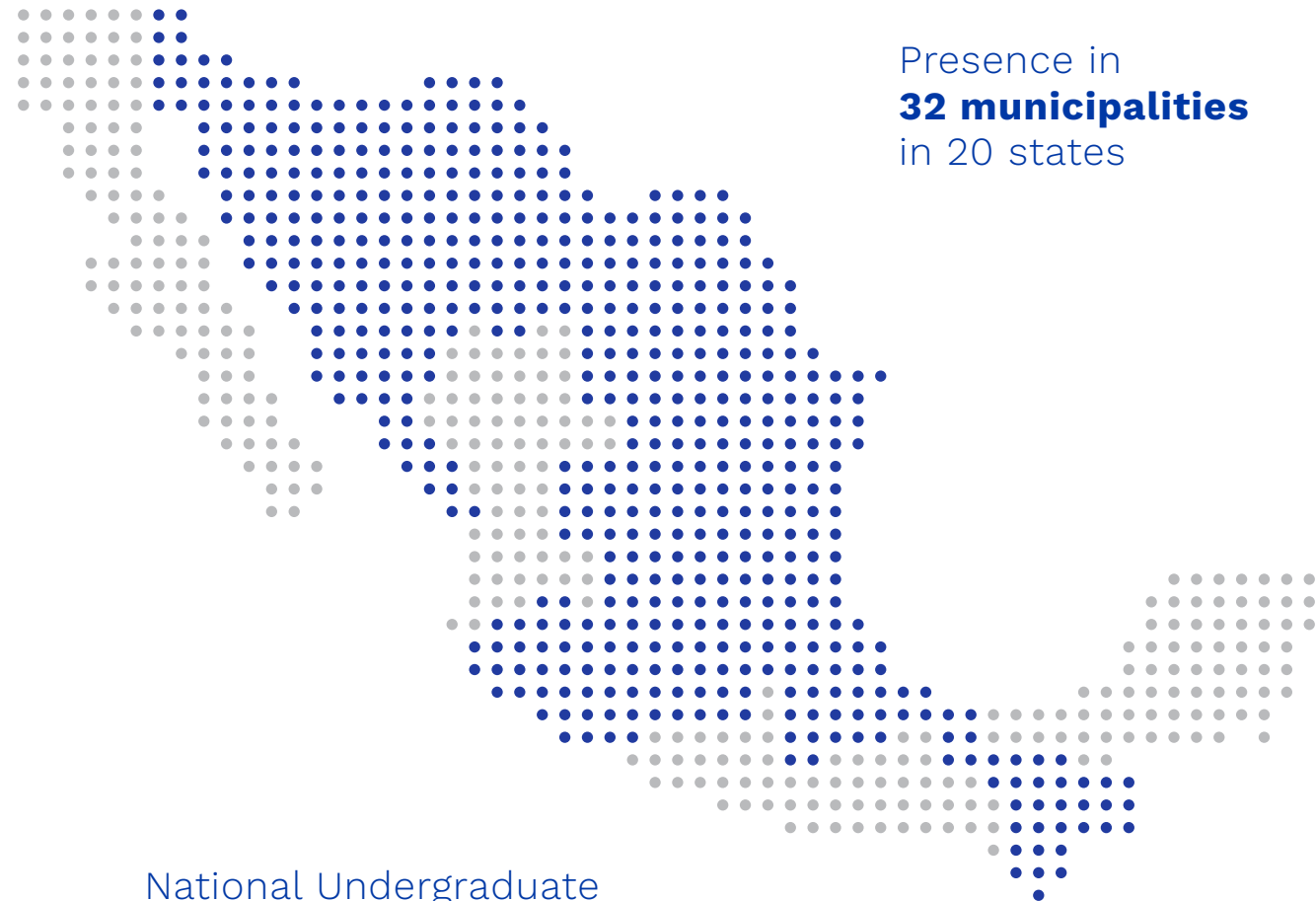
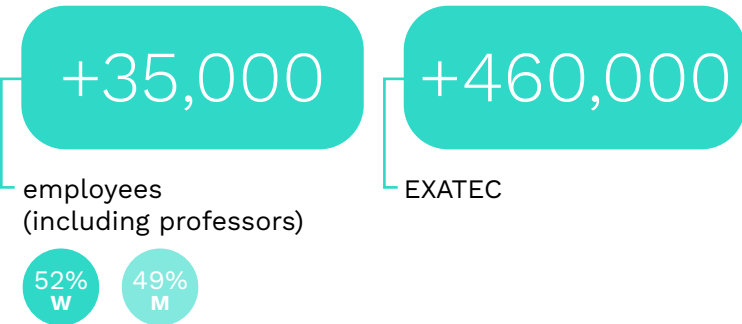

## National Undergraduate and Graduate Schools

- Architecture, Art and Design
- Engineering and Sciences
- Medicine and Health Sciences
- Social Sciences and Government
- Humanities and Education
- Business

## Academic Programs

- 44 Majors
- 38 Master's degrees
- 11 Doctoral degrees
- 5 Specialties
- 17 Medical specialties
- 3 High school programs

# ATTRACTING THE MOST TALENTED STUDENTS

## New Undergraduate Students

A new generation enrolled during the August-December 2023 semester

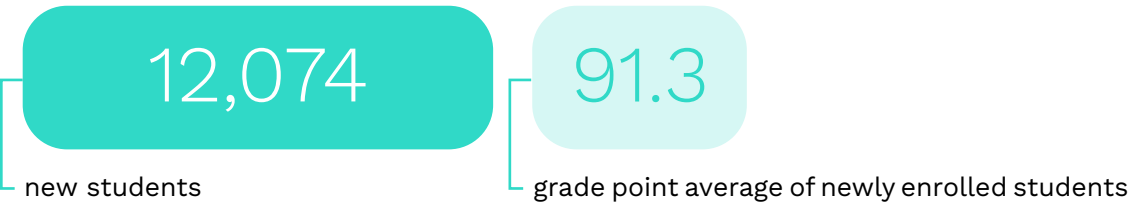

From:

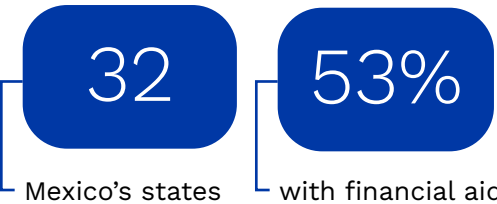
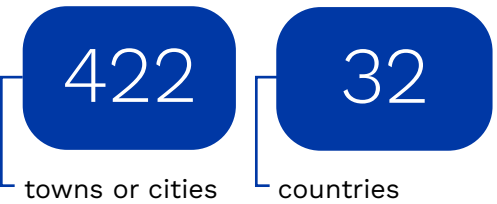

Regarding education, the students have experience in different areas:

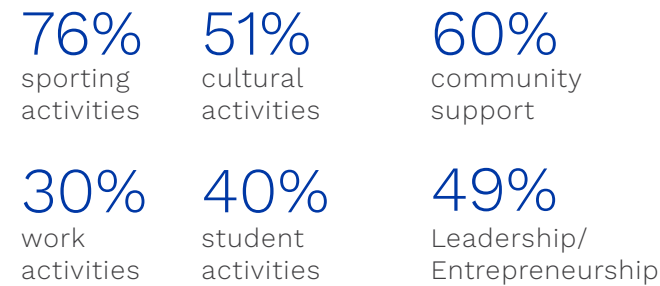

Distribution of enrollment according to school:

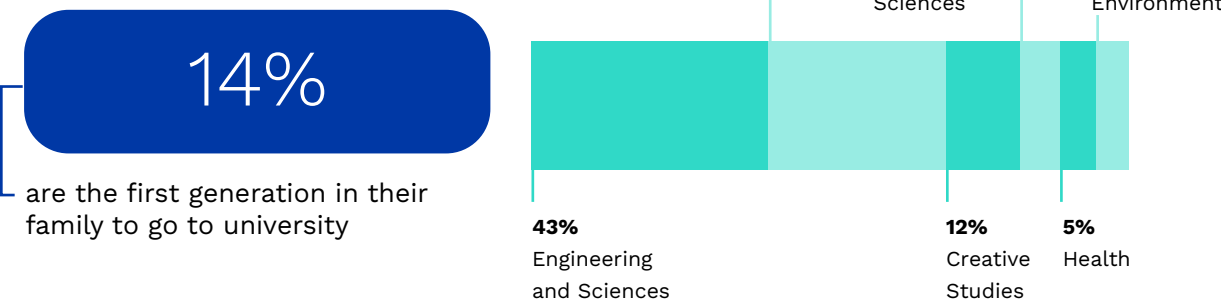

## New PrepaTec Students

In the August-December 2023 semester we welcomed:

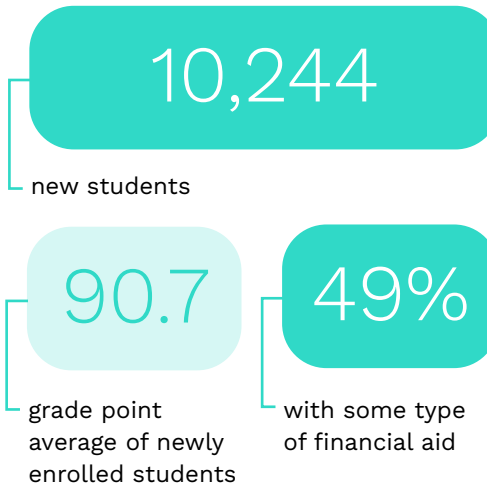

Distribution of enrollment according to program:

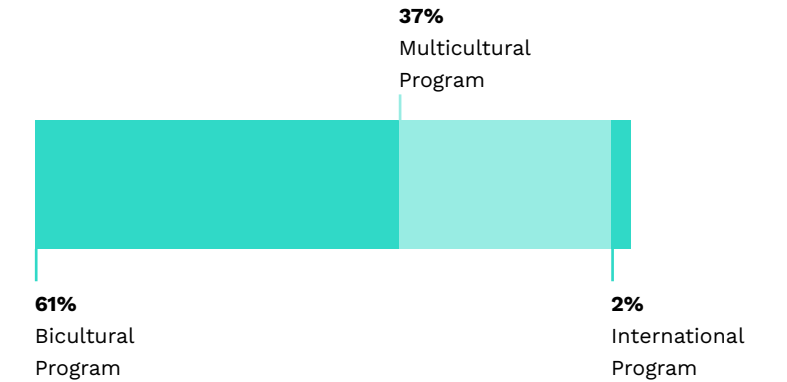

## New Graduate Students

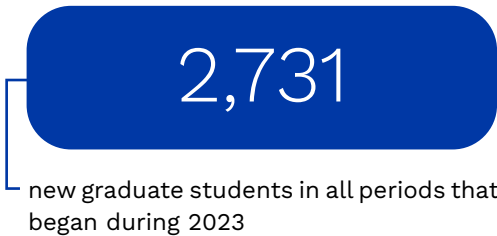
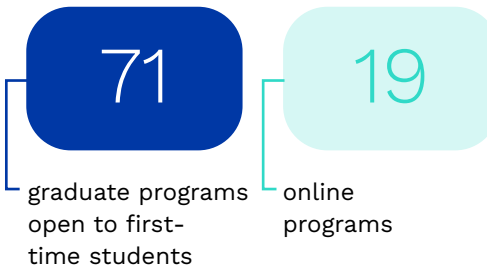

## LEADERS OF TOMORROW

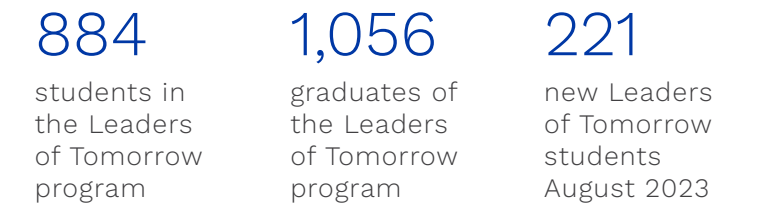

Leaders of Tomorrow's 10th Generation

# OUR STUDENT COMMUNITY

## Undergraduate

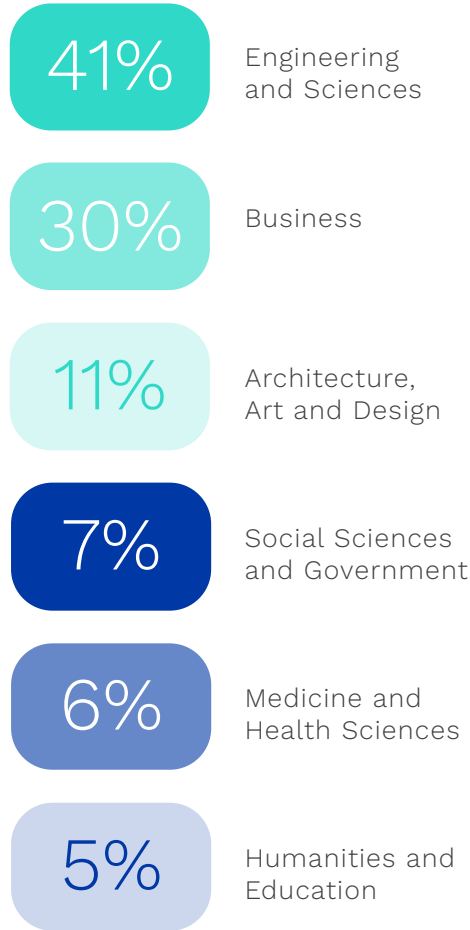
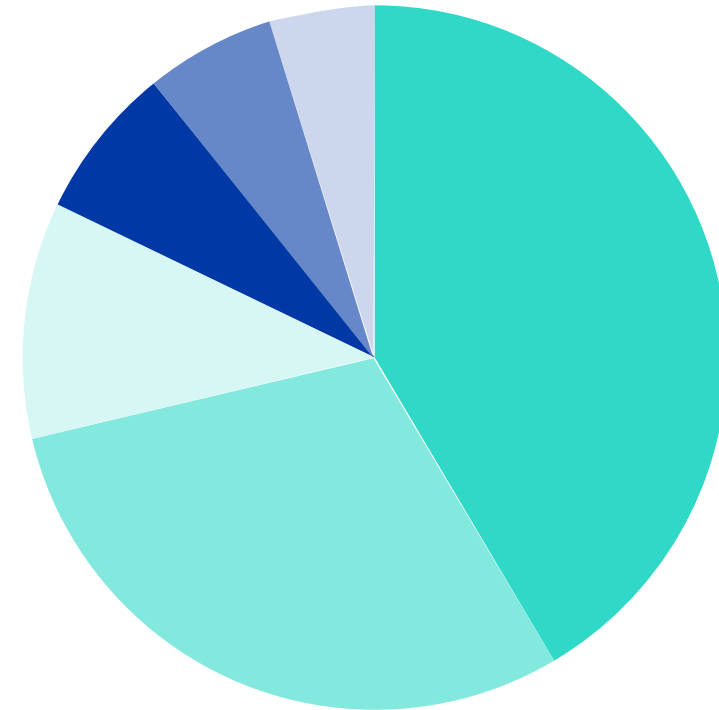

# 54,762

undergraduate students

48% financial aid

34% students from another state

1,550 temporary international students

## Graduate

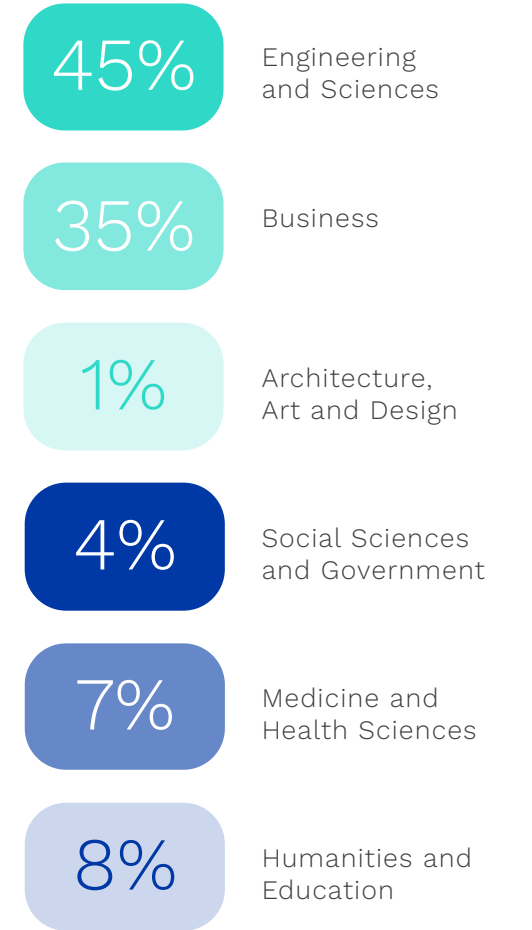
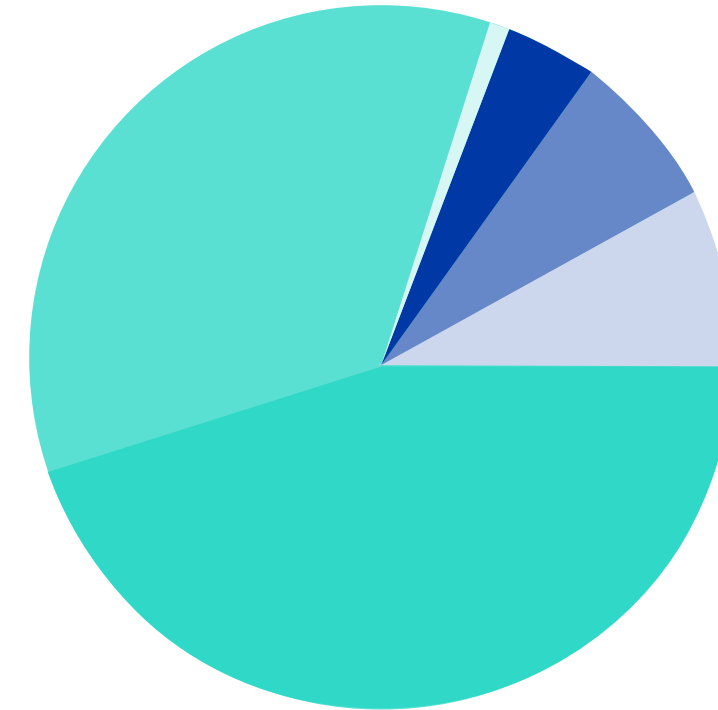

# 6,992

graduate students

93% financial aid

24% out of state



## INSPIRING FACULTY

8,685

faculty members taught undergraduate and graduate classes

66%

of faculty members had a 9 or 10 in their Student Assessment

(Encompasses full time faculty members teaching Tec21 from 2022 to 2023)

24% full time faculty members

61% of full time faculty members have a doctoral degree

41% of full time faculty members are alumni of foreign universities

19% of faculty members graduated from a Top 200 foreign university (the QS, THE and ARWU rankings of foreign universities are considered)(Se consideran los rankings QS, THE y ARWU de universidades extranjeras)

13% of faculty members are from another country

41% of faculty have graduate degree from another country

45,634 undergraduate and graduate group classes

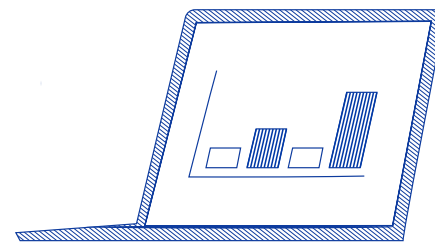

## RESEARCH

Talent dedicated to research

721

faculty members who are members of Mexico's National System of Researchers (SNI, in Spanish)

103

externally funded research and development projects

4

tech-based companies created at Tec with business partnerships: spinoffs, co-developments/equity

\*Launch of the new Additive Manufacturing CoreLab

\*Launch of the Early Childhood Center

9,328

publications in Scopus\* (\*international index of scientific journals) over a five year period

49%

publications with international collaboration

343

faculty members participated in the Research Professor Model

## CONTINUING EDUCATION

158,044 -

participants in Continuing Education programs in Mexico and Latin America

+2,220 -

Education partners, allies in the academic education of our Tec21 students

## GENEROSITY

660

million pesos were raised

76

million pesos with other efforts

## EXATEC

460,293

of which 359,589 are undergraduate and graduate alumni

39

active EXATEC associations in Mexico

19

active EXATEC associations abroad

Results of follow-up studies of alumni

85%

employment rate 3 months after graduation

97%

Employment rate 5 to 25 years after graduation

## RANKINGS

QS World University Rankings 2024



Times Higher Education Latin America University Rankings 2023



Times Higher Education Impact Rankings 2023

Globally measures the positive impact that universities are making in the world to contribute to the Sustainable Development Goals



Ranking The Princeton Review: Top Undergraduate Schools for Entrepreneurship Rankings 2024 & Entrepreneur Magazine

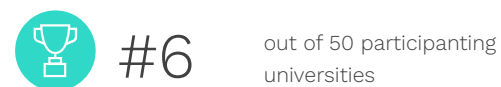

Global Employability University Ranking and Survey (GEURS) 2023-2024

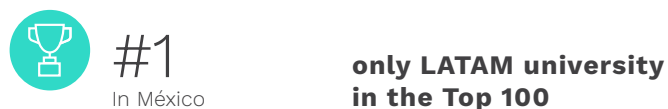

## TECSALUD

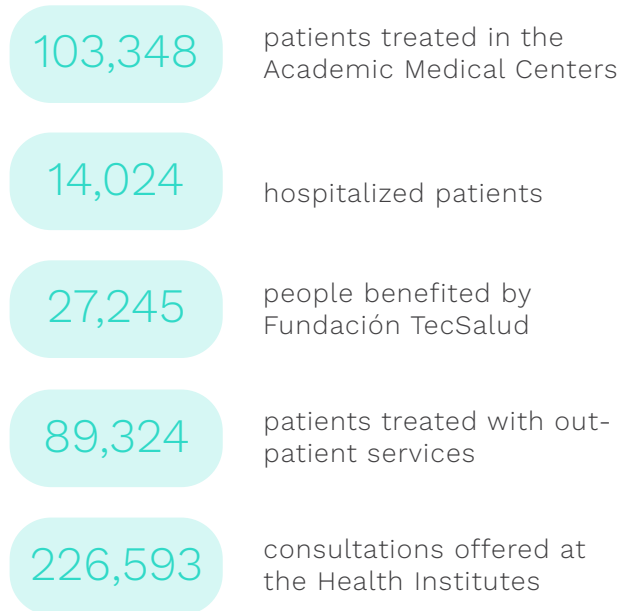

## INTERNATIONALIZATION

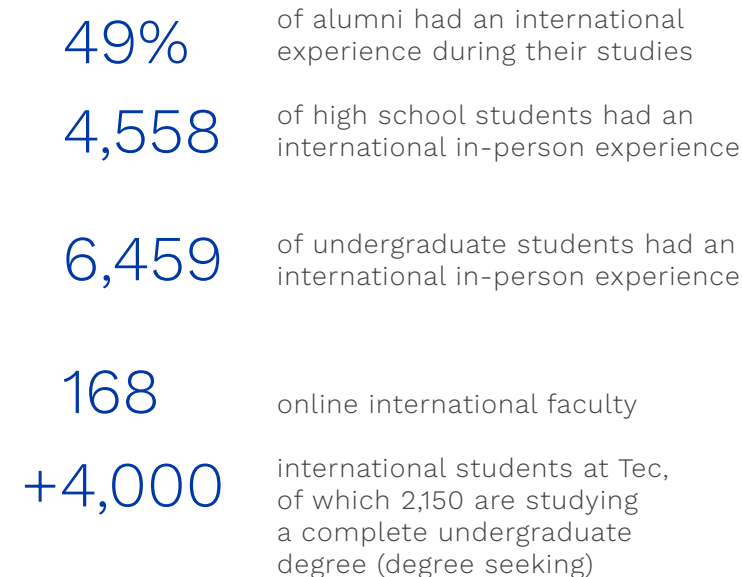

## TECMILENIO

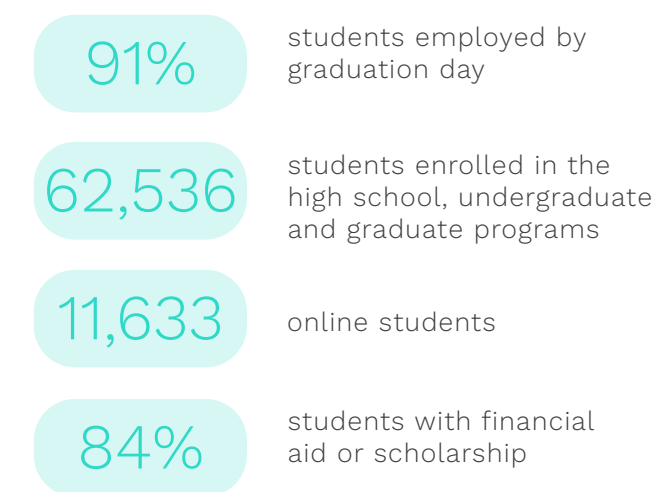

# Strategy

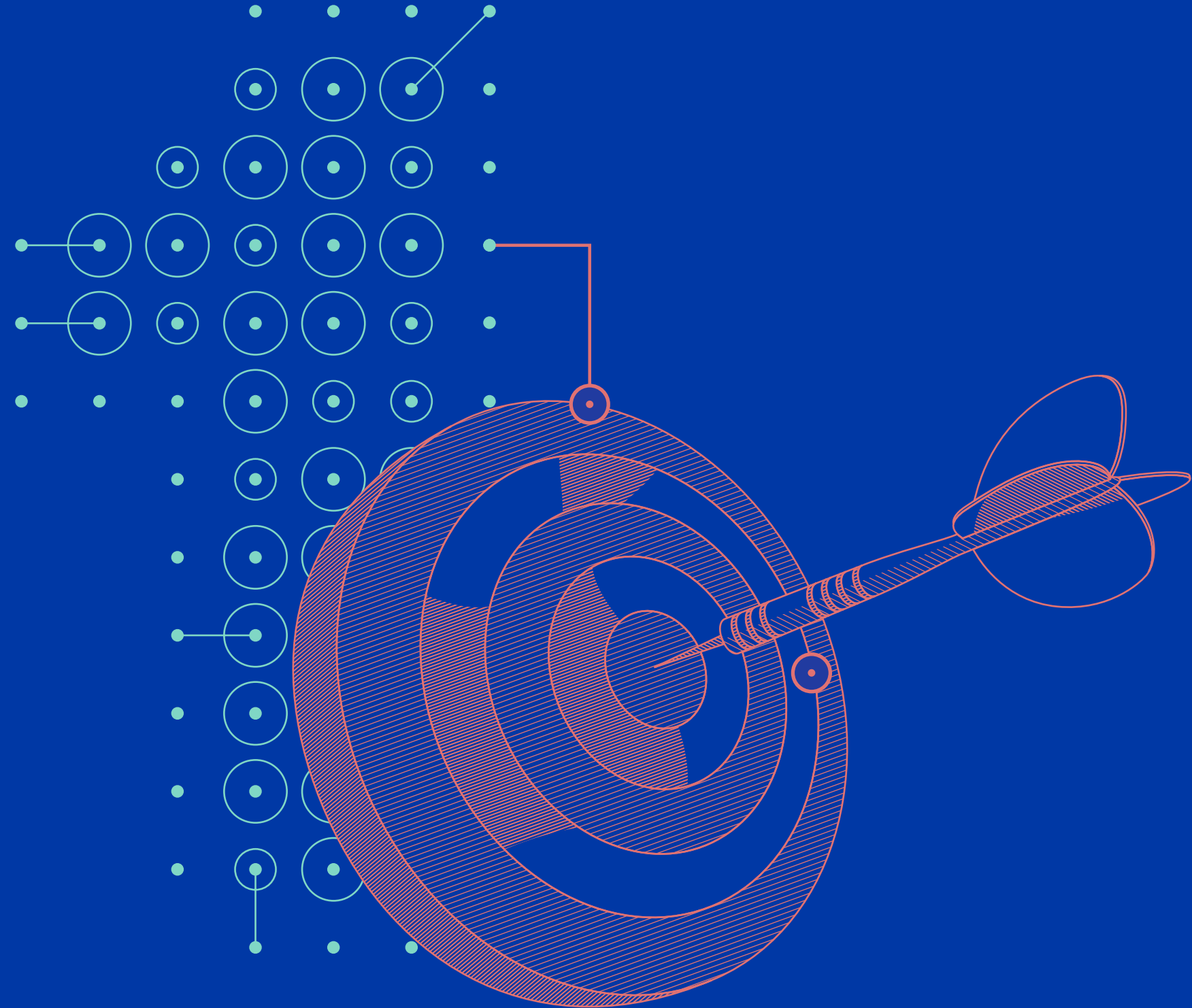

# Our guide to the future

## EVOLUTION OF THE 2025 PLAN

In 2023 we continue to make progress in consolidating our strategic plan. This year, we recognize the important progress that each of the initiatives, which comprise our plan, have achieved in line with our vision and the achievements defined for each of them.

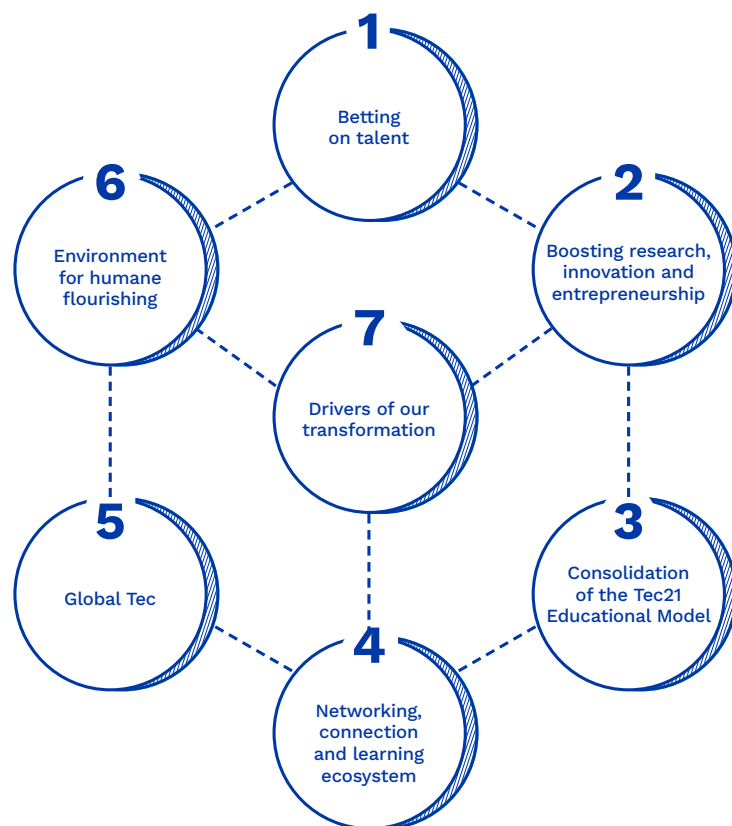

At the beginning of 2023, it was agreed to follow up with the projects that comprise the initiatives in three blocks: Transformational, Consolidation and Functional Priorities.

## TRANSFORMATIONAL PROJECTS

### Faculty of Excellence

The Faculty of Excellence seeks to attract global leading professors in their disciplines whose legacy is to strengthen Tec’s international prestige through the impact on our students, faculty, programs and society.

This year, **2 female professors and 8 international leading professors** for schools and institutes have joined the Faculty of Excellence.

Their expertise is in disciplines related to organizational behavior, gender equity, public leadership, participatory foresight, smart biomaterials, molecular biology and advanced manufacturing, among others.

By 2023, there are **26 professors** who comprise the Faculty of Excellence.

To read more details about this initiative, go to page 32

### Applied research: Interdisciplinary Research Institutes

We highlight some achievements and advances on several fronts: You can find more detail in the Research section (page 86)

#### Congress on obesity

The second International Congress of the Institute for Obesity Research (IOR) was held to seek solutions to this national problem.

#### Alliances

The Institute of Advanced Materials for Sustainable Manufacturing (IAMSM) established **agreements for the development of joint research with MIT (USA), UofA (Canada), NTU (Singapore), SwRI (USA)**. Cooperation was strengthened with the three research, innovation, technology transfer and entrepreneurship consortia, which continued to operate to boost scientific-technological development in the country.

A collaboration agreement was signed with **Regeneron Genetics Center to boost the oriGen project**, which seeks to expand the understanding of Mexican genetic identity to accelerate advances in health.

#### Scientific and Technologically-based Ecosystems and Entrepreneurships

The creation of 8 scientific-technological based companies with links to the Tec de Monterrey was formalized.

**MIT REAP Focus Mexico** achieved the implementation of strategies in CDMX, Guadalajara, Chihuahua, Guanajuato and Querétaro.

Venture Café

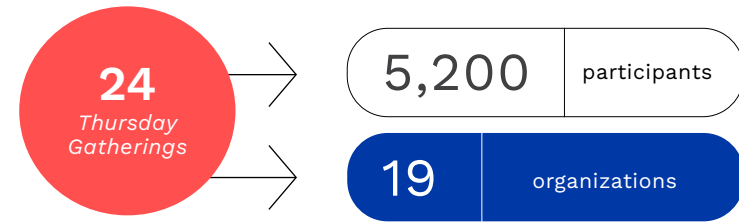

Venture Café continued its consolidation as an open space for actors in Monterrey’s innovation and entrepreneurship ecosystem.

The Next Decade: Water Disruption

In addition, the first edition of **The Next Decade: Water Disruption** was held, a space in which leaders from the public and private sectors met to discuss solutions for the future of water in our country.

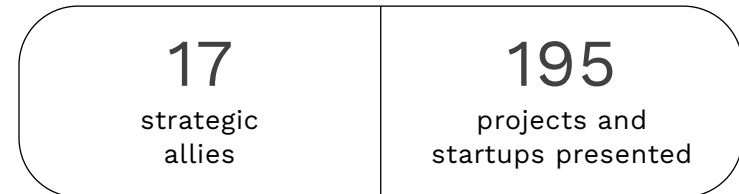

Connection, Learning and Creation Platforms

Attraction of **27,000 registered users** on 5 **platforms** that provide differentiated experiences, all of them with a solid data analysis strategy for the detection and creation of new value models.

To learn more details about this project, see page 76

Evolution of Continuing Education

We consolidated The Learning Gate learning ecosystem, an innovative and high-impact learning ecosystem for the development of leaders with high potential. The ecosystem offers a comprehensive learning experience through +278 competencies and sub-competencies, customizable and on demand, with support to enhance the achievement of goals of our “game changers & learners”.

Additionally, we expanded our operations to Brazil, Chile, Costa Rica, El Salvador and the Dominican Republic.

**Además, expandimos nuestras operaciones a Brasil, Chile, Costa Rica, El Salvador y República Dominicana.**

Currently, 16% of Continuing Education projects are for organizations out of Mexico.

For more details, go to the Continuing Education section (page 59)

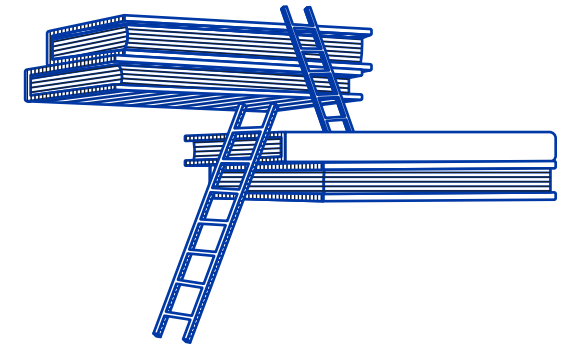

PROJECTS IN CONSOLIDATION

Consolidation of Tec21 Educational Model

The eighth semester educational units were successfully implemented, where multidisciplinary blocks stand out (educational units where a challenge is solved in collaboration with students and professors from different disciplines).

The design of the 2026 curriculum update began with more than 200 professors.





33,713 disciplinary competency credentials (digital curricular credentials that certify the practical competencies and skills that graduates acquired in their education) were delivered to 6,589 graduates of the first generation of 2019 plans.



To learn more details, go to the Tec21 Educational Model section (page 26)

### Blue Route

We assume the commitment to significantly reduce the use of PET and disposables in the Institution. The disposal of +147,000 single-use plastic bottles has been avoided in 8 flagship and/or multi-campus events of the Institution.

The first measurement of the Sustainability Culture Index was carried out, an instrument that measures the attitudes, behaviors, ideologies and knowledge of the Tec community.



### Regarding 2019

In Tec de Monterrey and TecSalud facilities we achieved

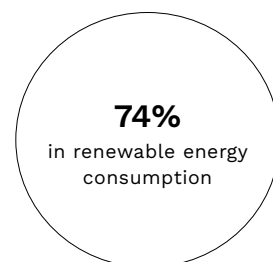

At Tec de Monterrey, TecSalud and Sorteos Tec we achieved

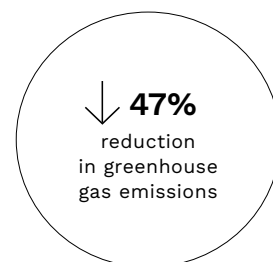

In THE Impact Ranking 2023, that evaluates the progress of universities in relation to the UN Sustainable Development Goals (SDGs), Tec position is:



To learn more details about the initiative, see page 128



## FUNCTIONAL PRIORITY PROJECTS

### Attraction of national and international student talent

Consistent with Tec de Monterrey's internationalization effort, this year we registered the enrollment of

**553** new international students completing their degree

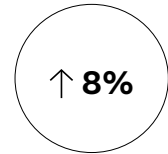

It is the highest number of international students new to the Institution in the last 10 years.

To know more details, consult page 35

### Wellness

**95%**

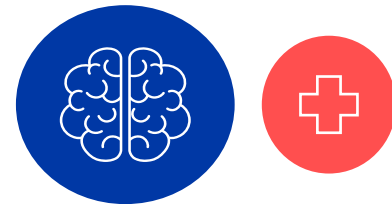

of first-year students who take introductory subjects have an index of comprehensive personal well-being and together with their Student Mentors, they reflected on their goals and strengthened their life plan to develop their well-being in different dimensions.

Students were accompanied with alerts from the "Healthy Minds Study", strengthening attention with the hiring of national figures Leader of alert referral for the three academic levels and implementing the new Student Wellbeing structure on the main campus.

Those that have automatic defibrillator devices were declared as protected cardio campuses, having a total of:



Tec de Monterrey is the first university in Mexico to have this effort.

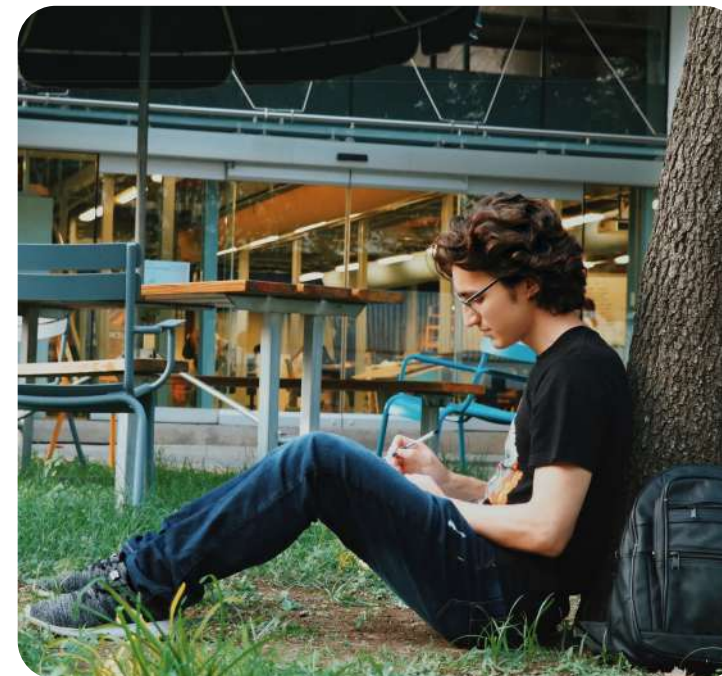

## Diversity, equity, inclusion and belonging.

**+235**

female students from Tec and Tecmilenio

**19 Campuses**

participated in the *Patrones Hermosos and Woman for the Future STEM (Science, technology, engineering and mathematics) workshops.*

*The First Summit of the Impulsa Network "Inspire, connect and flourish" was held, bringing together more than 120 women leaders and their mentors. And another 51 women leaders, directors and academics completed the WILL: Women In Learning and Leadership group mentoring program.*

It was possible to reach the goal for 2025 of having 30% women in directive positions.

To know more details, read the Our Organization section (page 125)

### Arts and culture at Tec

During this year, within the 80th anniversary of the Institution, the relaunch of the Artistic Society of Tecnológico (SAT, in Spanish) was achieved, an initiative to promote high-level artistic events.



## Strengthening a culture of generosity

The causes of Tecnológico de Monterrey allow us to influence as a platform for transformation.

### Historical procurement of:

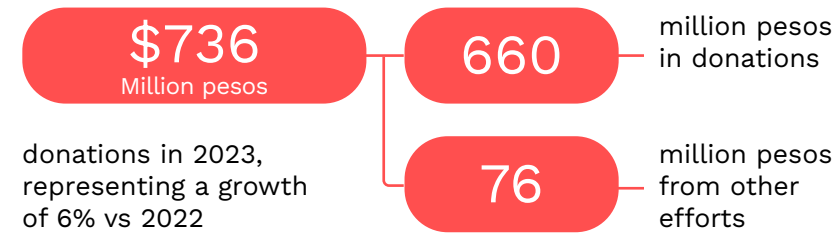

We reaffirm our commitment to boosting education through academic talent, research, innovation and entrepreneurship, and the creation of environments that foster learning experiences to positively impact our community.

### Main achievements

**+360** scholarships in perpetuity awarded to Leaders of Tomorrow

**70%** progress of the financial goal = **\$3,896 million pesos** from the Leaders of Tomorrow fund.

Historic donations to create the Eduardo Garza T. Innovation and Entrepreneurship Hub and the Carlos Álvarez Design and Engineering Center on Campus Monterrey, and on Campus Guadalajara the José Luis González Íñigo Borregos Arena and a fund for sports scholarships.

To know more details, consult page 95



## Digital Route

**Tec de Monterrey, through its TECgpt platform,** becomes the first university in LATAM to develop a solution that uses natural language to consult knowledge databases with information produced by the Institution and with self-generated responses through artificial intelligence generative. This technological solution will be available to all employees, as well as students through various applications at the beginning of 2024.

To learn more details about this initiative, see page 126

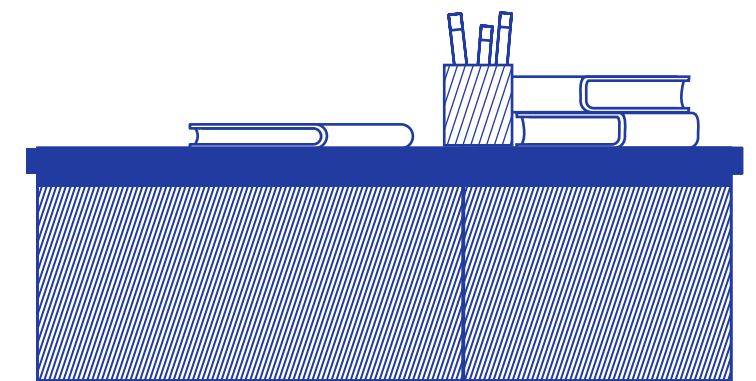

# Tecnológico de Monterrey



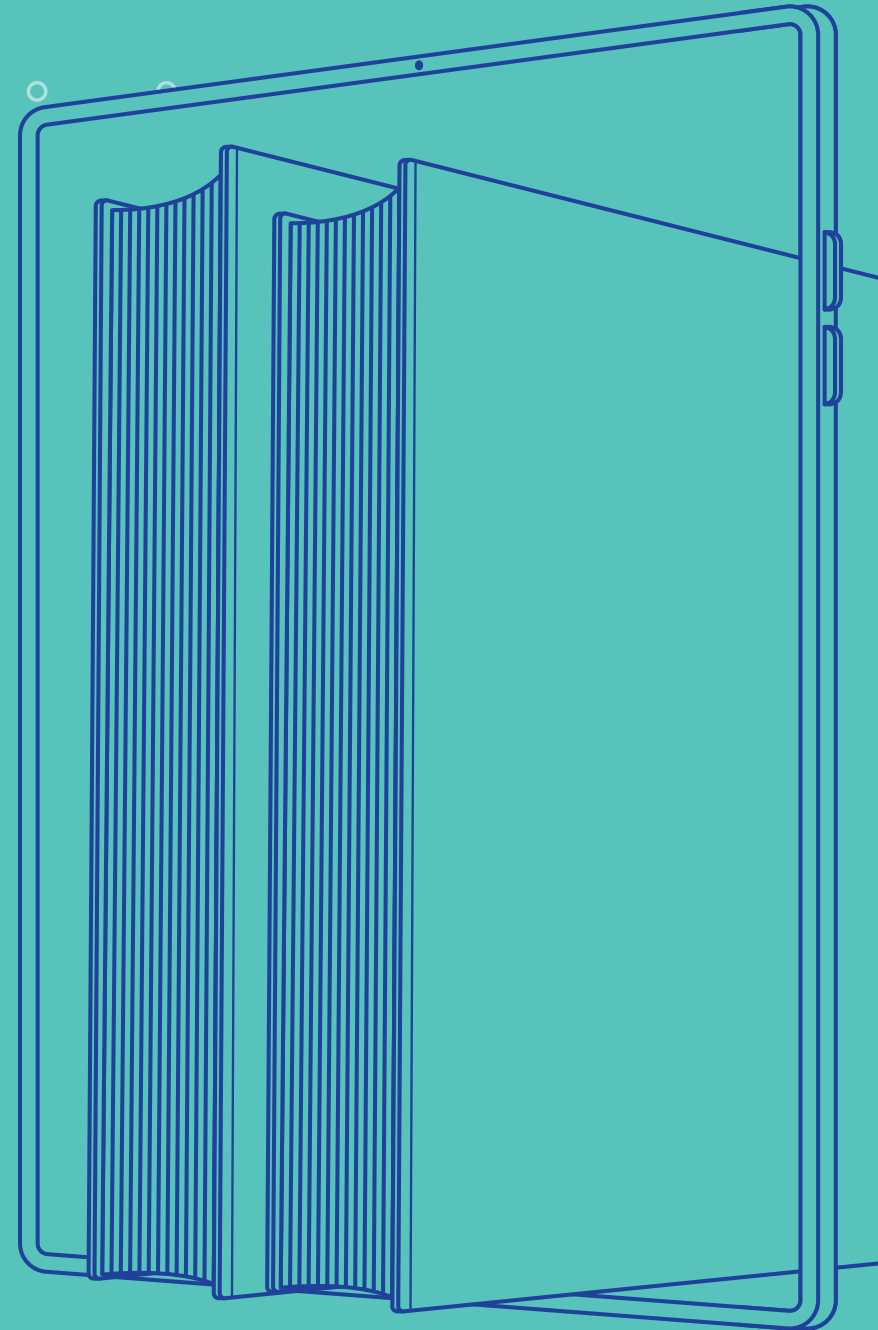

Educación





# Educational Model

# Tec21 Educational Model

The Tec21 Educational Model has allowed students to acquire solid and comprehensive skills to face current and future challenges in a creative and strategic way.

In 2023, the graduation of the first generation under the Tec21 Educational Model was celebrated, graduating 6,589 students, granting them academic degrees and Curricular Credentials that certify their comprehensive development in disciplinary competencies.

As part of the continuous commitment to improvement, activities such as Tec Week and Tec Semester are strengthened, introducing new features such as multidisciplinary blocks, workshops for end-of-degree exams and the Tec Week for Final Stage Evaluation. In addition, progress has been made in the design of the eighth semester of all programs, with more than 250 educational units, and new units are being developed for quarterly programs of the School of Medicine and Health Sciences, along with elective units, totaling more than 1,500 educational units in constant improvement in all academic programs.



During the same year, a total of 37,959 Tec21 groups were taught in different academic periods, demonstrating the successful implementation of our strategies.

Winter 2023

**1,304 groups**

February-June 2023

**16,721 groups**

Summer 2023

**1,139 groups**

August-December 2023

**18,795 groups**

## MILESTONES IN THE HISTORY OF THE TEC21 EDUCATIONAL

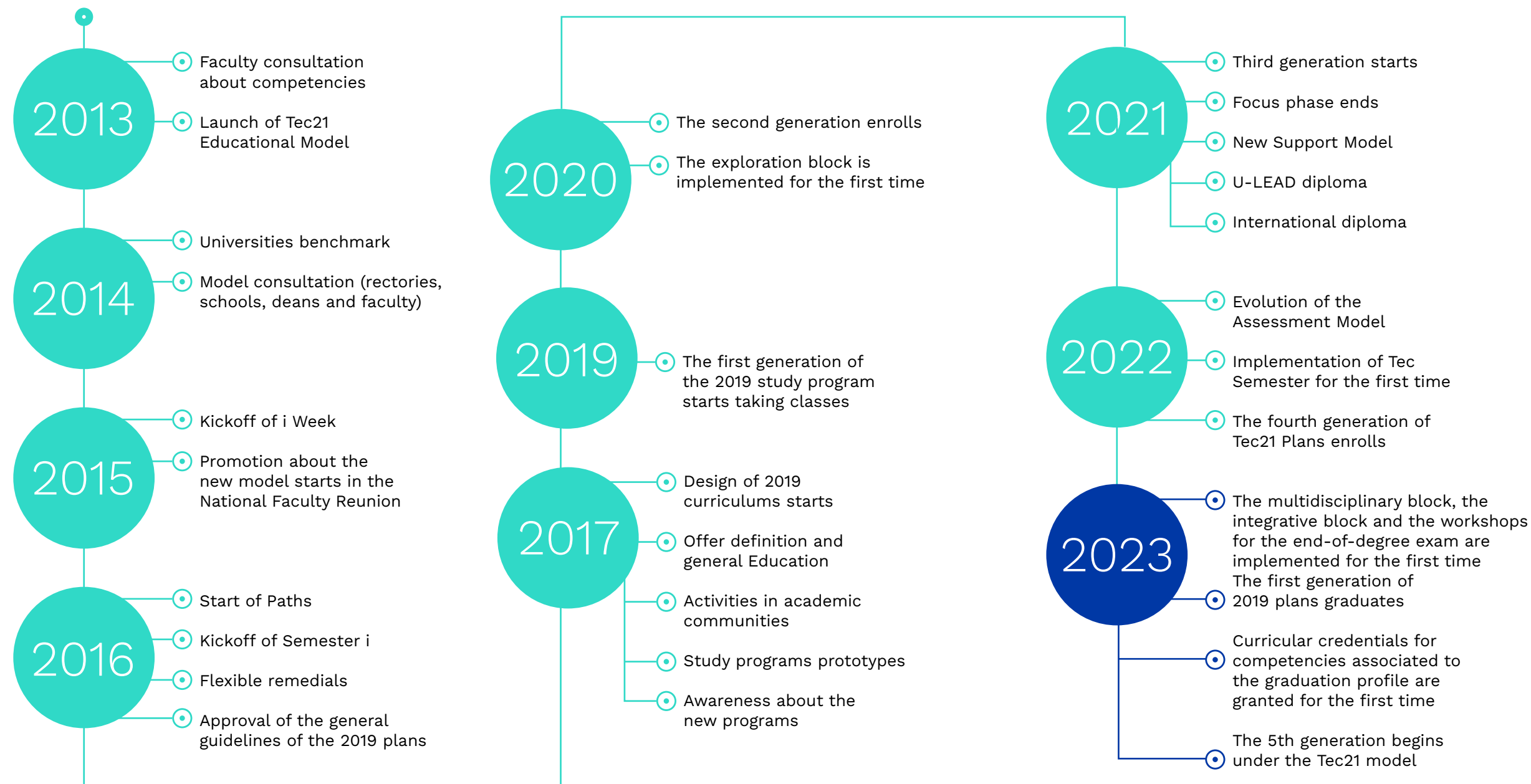

The year 2023 has seen significant progress in the consolidation and continuous improvement of the Tec21 Educational Model at the Tecnológico de Monterrey. The positive results and growing acceptance among the student community support the effectiveness of this innovative approach, reaffirming our commitment to academic excellence and the comprehensive education of professors, students and the entire educational community.

## GRADUATION OF THE FIRST GENERATION OF THE TEC21 EDUCATIONAL MODEL

In 2023, we celebrated the graduation of the first generation of the 2019 Study Plans, marking a milestone in the competency-based educational model. Focusing on recognizing and evidencing the comprehensive development of competencies aligned with the graduation profiles, we implement the Curricular Credentials of Disciplinary Competencies.

The **Curricular Credentials of Disciplinary Competencies** were implemented, aligned with the educational trend and the principles of the Tec21 educational model. These credentials represent the integrated development of a disciplinary competency and are given to graduates when they demonstrate all subcompetencies associated with the highest level of mastery, in accordance with the curriculum.

The successful implementation of the Curricular Credentials of Disciplinary Competencies underlines the continuous commitment of Tecnológico de Monterrey to educational innovation and the comprehensive education of its students. This achievement positions our graduates as outstanding and differentiated professionals, reinforcing their relevance in the workplace.



## TEC WEEK

Tec Weeks are consolidated, educational units that provide significant immersion in competencies and exploration of skills. These experiences, scheduled in weeks 6, 12 and 18 of each semester, offer activities designed to develop competencies, allowing students to discover new skills both on and off campus.

With the aim of providing greater flexibility and regularization options, new alternatives have been introduced to take Tec Weeks. Students now have the option of enrolling in authorized Continuing Education programs or accrediting Tec Weeks by participating in equivalent, previously authorized educational experiences. by the Alternative Credentials and Assessment Center.

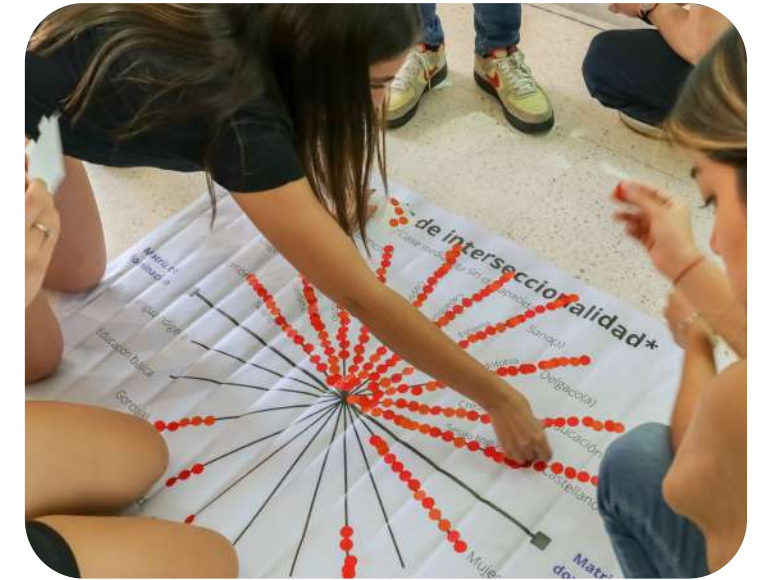

47,146

students who participated in Tec Weeks

9,697

Tec Weeks during the year

489

Tec Weeks groups had an training partner



## TEC SEMESTER

Tec Semester, focused on the specialization stage (sixth, seventh and eighth semester), provides students with the opportunity to deepen or expand their education through various learning experiences, such as concentrations, international exchanges, professional stays and elective subjects.

# 17,036

students enrolled in the Tec Semester in the periods February – June 2023 and August – December 2023, distributed as follows:



Some notable examples of relevant projects carried out during the Tec Semester 2023 were:

### Automotive Engineering Concentration:

Vehicle electrification project with METALSA.

### Diplomatic Studies:

Regional integration consulting project with the Matías Romero Institute.

The Tec Semester is enriched with the active participation of Education Partners from various industries. Some examples of partners that actively collaborate in this initiative include: **Afirme, Alfa Fundación, Amber Studio, Anima Studios, ATOS global delivery, Banorte, Bosh, Boxel Studio, Cámara de Joyería del Estado de Jalisco, Chavo Animation Studios, Citelis, Danone, Deloitte, International Book Fair, General Motors, Gilsa, HEB, IBM, IK Joyeros, Matías Romero Institute, Invomex, Liverpool, Meta (Facebook), Metalsa, Microsoft, Museo Marco, Near Futures Laboratory, Nematik, Pearson, MURAL Newspaper, Pirelli, Sigma Foods, SEMARNAT - Sierra Gorda Biosphere Reserve, Studio Algoritmo, Undersecretary of Infrastructure of the state of Nuevo León, Taller del Chucho (Guillermo del Toro), Televisa, Ternium, Ware Malcomb.**

Currently, we have

## +2,200

Education Partners who actively contribute to the academic and professional education of our community. Close collaboration with Education Partners and successful execution of outstanding projects reflect the effective connection between academia and industry.



## Transversal Competencies

Tecnológico de Monterrey is advancing in the definition of transversal competencies for updating the 2026 study plans, focusing its attention on educational quality and relevance. In response to the need for adaptability and appropriateness in higher education, as an Institution we reviewed and updated these competencies.

Based on the learnings from the 2019 study plans, guiding principles were established that seek to reduce the number of competencies to maximize their development, align with the 2030 vision of Tecnológico de Monterrey, support the proposal in solid documentary research and consider sustainability as a fundamental criterion. fundamental.

The process of defining transversal competencies for the 2026 study plans reflects the institution's continuous commitment to educational quality and the comprehensive education of students. The involvement of diverse stakeholders and adherence to sound guiding principles ensure that the education provided responds effectively to the present and future demands of the academic and work environment.

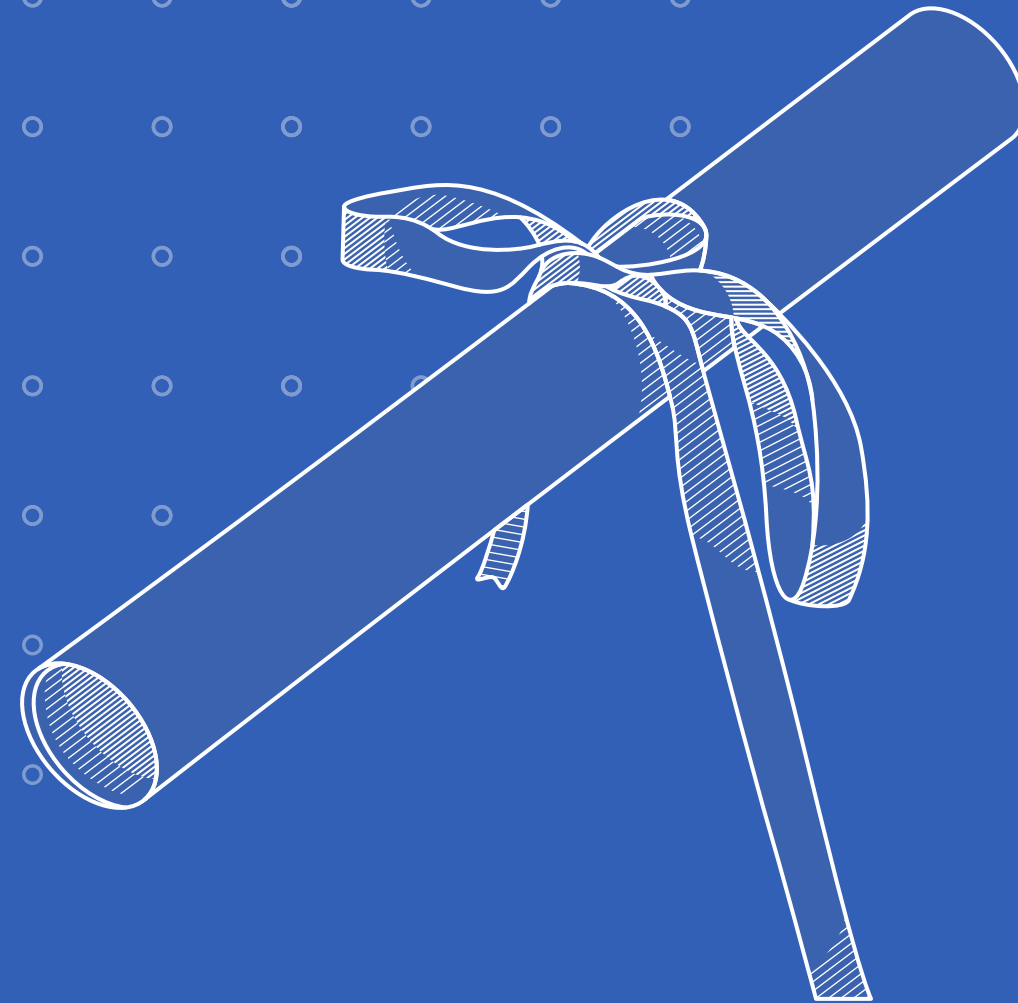
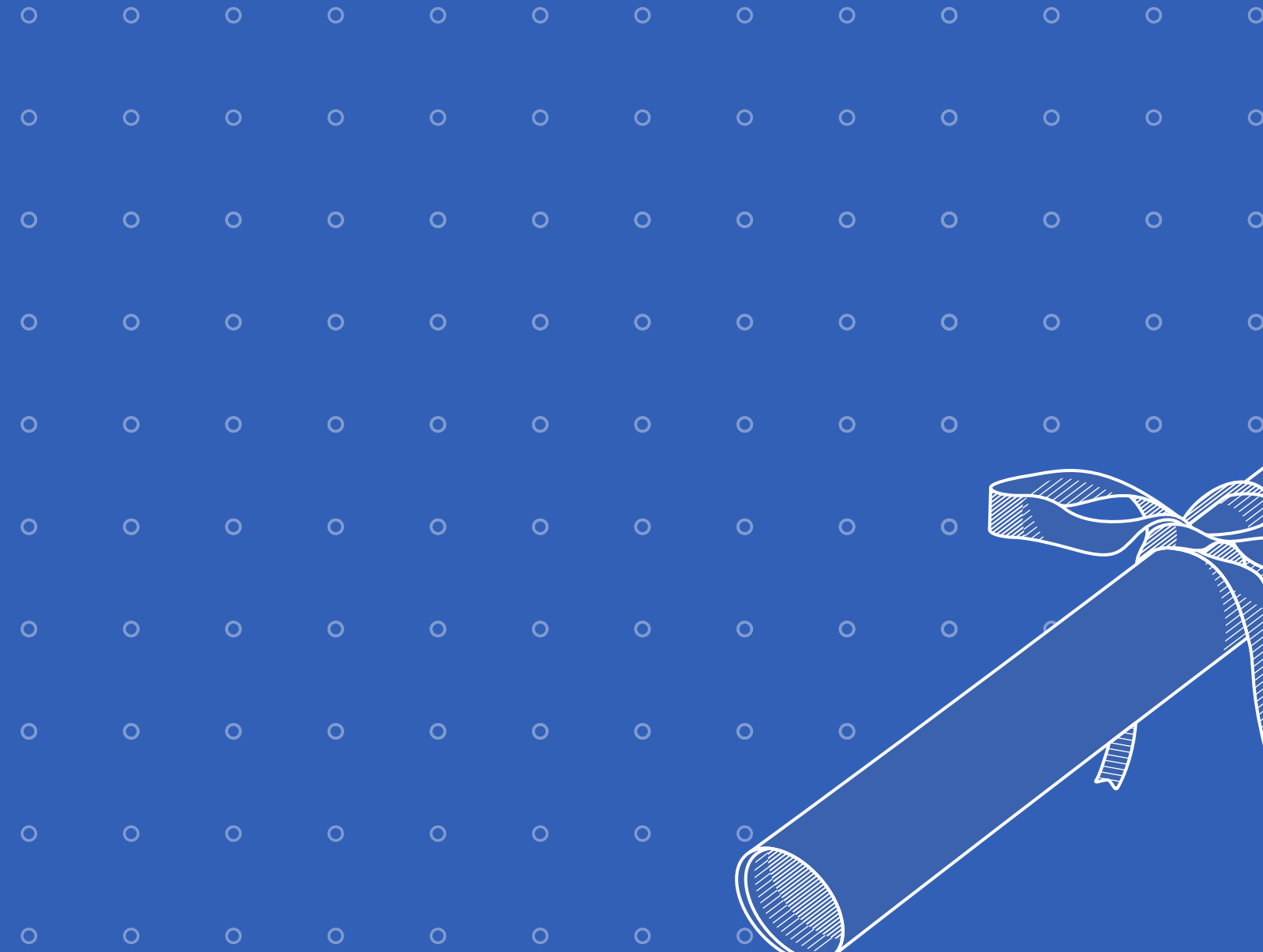

Faculty

# Faculty

The Faculty of Tecnológico de Monterrey is a robust academic body, comprised of

11,380

professors at various educational levels.



In Undergraduate and Graduate:

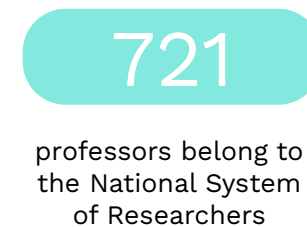

## ATTRACTION OF THE BEST ACADEMIC TALENT

In 2023, the faculty experienced a significant strengthening with the incorporation of new talents:

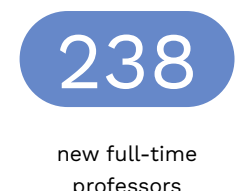

The hired full-time professors have an outstanding profile:

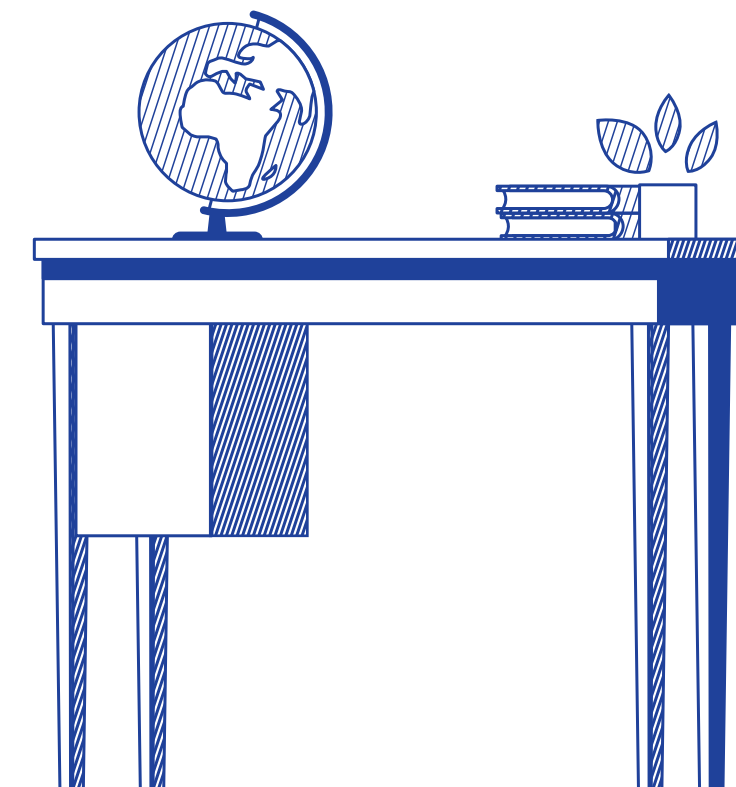
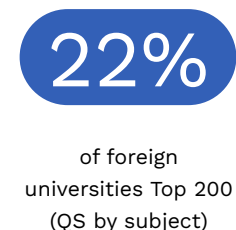

## “FACULTY OF EXCELLENCE” INITIATIVE

This initiative seeks to incorporate 100 global leading professors by 2026. In 2023, 10 professors joined, adding 26 professors in the Faculty of Excellence initiative.



Rob Roggema  
EAAD



Manish Kumar  
EIC



Sergio Fajardo  
ECSG



Ana Mallet  
EAAD



Raj Sisoda  
EN | EGADE



Oliver Schilke  
EN | EGADE



Martin Reimann  
EN | EGADE



Cipriano Santos  
EIC



Richard Wilson  
EMCS



Alejandro Echeverri  
EAAD



Steven Popper  
ECSG



Gabriel Luna  
EIC / IAMSM

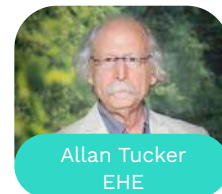

Allan Tucker  
EHE



Nilima Bhat  
EHE / EN



Carlos Coello  
EIC



Peter Jones  
EAAD



Marc Madou  
EIC



Tony Silard  
ECSG



Sigfredo Fuentes  
EIC



Francisco Falcone  
EIC



Per Olof Berggren  
EMCS



Juan Ignacio  
Sánchez EN / EGADE



Zaida Muxí  
EAAD



Frank Loge  
EIC



Dhruv Grewal  
EN



Thomas Kurfess  
EIC

## FACULTY’S DEVELOPMENT AND WELLBEING

Through the Center for Professor Development and Educational Innovation (CEDDIE), various initiatives are implemented:

### Discipline Update Courses (CADi):

213 courses with the participation of 6,496 professors strengthening their disciplinary knowledge.

### Strategy to boost the use of Artificial Intelligence in the teaching-learning process:

4,700 professors actively participated in the series of talks, workshops, bootcamps, resources and pilot projects with expert professors and pioneers on the subject.

### Faculty internationalization initiative:

1,237 professors developed their international profile through courses, stays, conferences, CADis abroad and International Faculty Week.

### Faculty Wellbeing Program:

3,267 professors participating in various talks, workshops, meditation days, “Live wellbeing” activities and CADis.



## EVOLUTION OF THE FACULTY CLASSIFICATION 2023

Undergraduate and Graduate

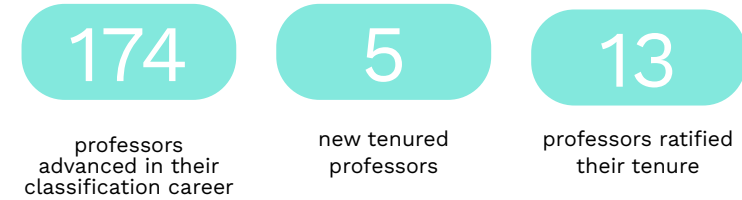

**Janet Alejandra Gutierrez Uribe**  
School of Engineering and Sciences  
Puebla Campus



**Juan Manuel Fernández Cárdenas**  
School of Humanities and Education  
Monterrey Campus



**Cristina Elizabeth Chuck Hernández**  
School of Engineering and Sciences  
Monterrey Campus



**Héctor Alfonso Barrios Piña**  
School of Engineering and Sciences  
Guadalajara Campus



**René Cabral Torres**  
EGADE  
Monterrey Campus

## AWARDS AND HONOURS

The Faculty of Tecnológico de Monterrey stands out for the Recognition of its members:

### Inspiring Professors Award 2023:

The Inspiring Professors Award recognizes excellent teaching work, as well as the leadership and impact of our faculty at the high school, undergraduate, and graduate academic levels. The distinction was awarded to **8 professors at the national level, and 50 professors were also recognized at the campus level.** For the first time, winning professors were recognized on the national stage.



**Eva María Guerra Leal**  
School of Business Monterrey Campus



**Carlos Ariosto Alonzo Gordillo**  
High School - Adjunct professor  
Chihuahua Campus



**Luis Carlos Félix Herrán**  
School of Engineering and Sciences - Sonora Norte Campus



**Maruma Godoy Rangel**  
High School - Esmeralda Campus



**Jaime Mora Vargas**  
School of Engineering and Sciences - Adjunct professor  
Estado de México Campus



**Ramiro Arturo Guzmán Jiménez**  
School of Business - Adjunct professor  
Mexico City Campus



**Oscar Alejandro Medrano Lamelas**  
High School - Chihuahua Campus



**Marilena Antunes Ricardo**  
School of Engineering and Sciences - Monterrey Campus

### Featured Professors Circle Program:

Celebrates the high performance of a select group of professors recognized for their achievements in teaching, intellectual vitality and service. In 2023, 268 professors were selected within their Schools, increasing to a total of 596 professors recognized in the four editions of this distinction.

## PROFESSORS WHO LEAVE THEIR MARK

**918 professors and former professors were recognized** by the community of Tecnológico de Monterrey's alumni as "Professors who leave their mark." The ceremonies were held within the 80th anniversary of the Institution.

## 2023 NATIONAL PROFESSORS REUNION

The RNP (in Spanish) allowed the celebration of the impact of the Faculty throughout the 80 years of Tec's history, with the participation of around 4,000 professors.





# Internationalization

# Internationalization

In 2023, 49% of Tec de Monterrey bachelor graduates had international experiences.

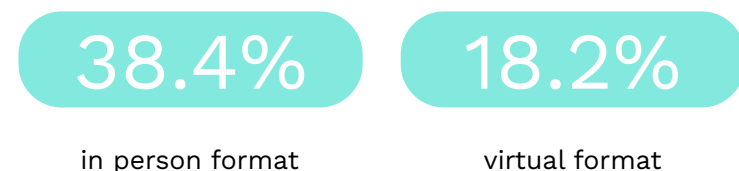

Progress was made in the renewal, updating and creation of 227 academic cooperation agreements for mobility and distance learning for high school, undergraduate and/or graduate levels. This allowed a total of 1,006 agreements in force and active in 2023 with 725 universities and partner entities from 54 countries.

## INTERNATIONAL MOBILITY AGREEMENTS

This year we worked on the renewal, updating and creation of **196 academic agreements**, of which **174 were for undergraduate level, 11 for graduate and 11 for both levels.**



On the other hand, PrepaTec reported the signing of **31 academic agreements** that allowed a total of **39 current and active agreements with 28 partner entities from 10 countries.**

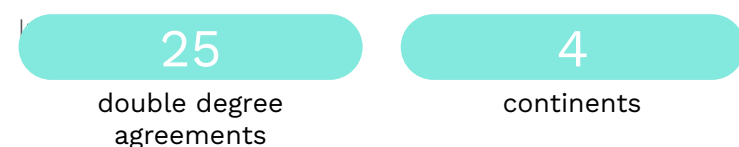

## INTERNATIONAL MOBILITY WITH ACADEMIC CREDIT

6,459

students actively participated, taking courses with curricular value, internships, medical rotations and research stays in both in-person and digital formats.

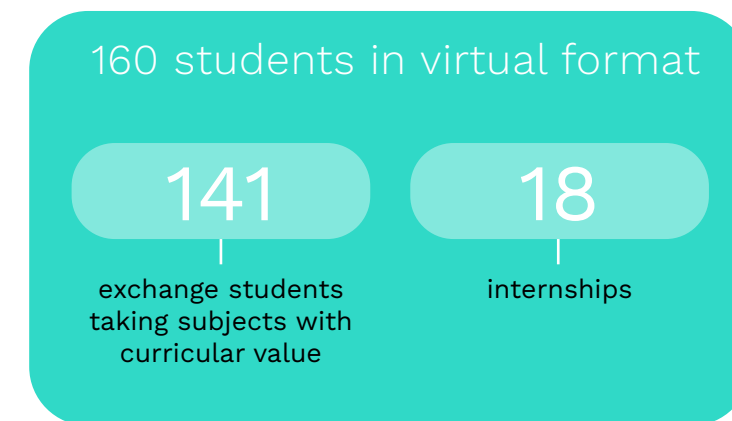
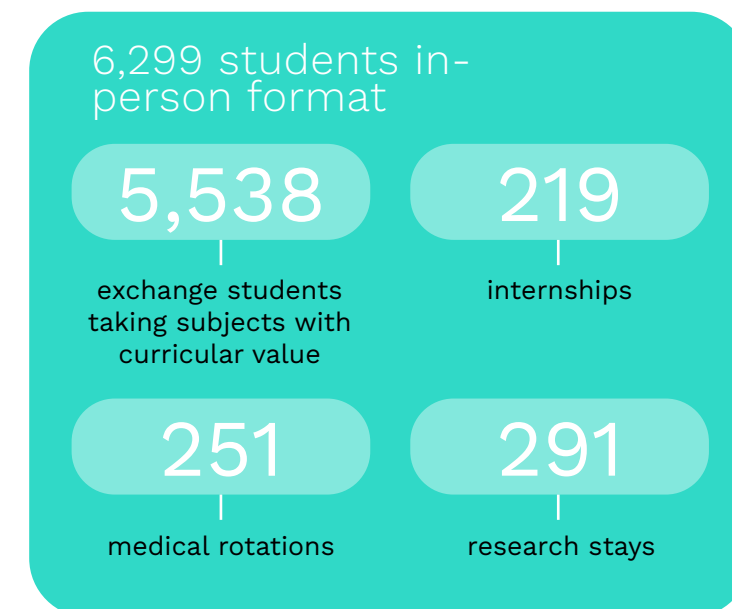
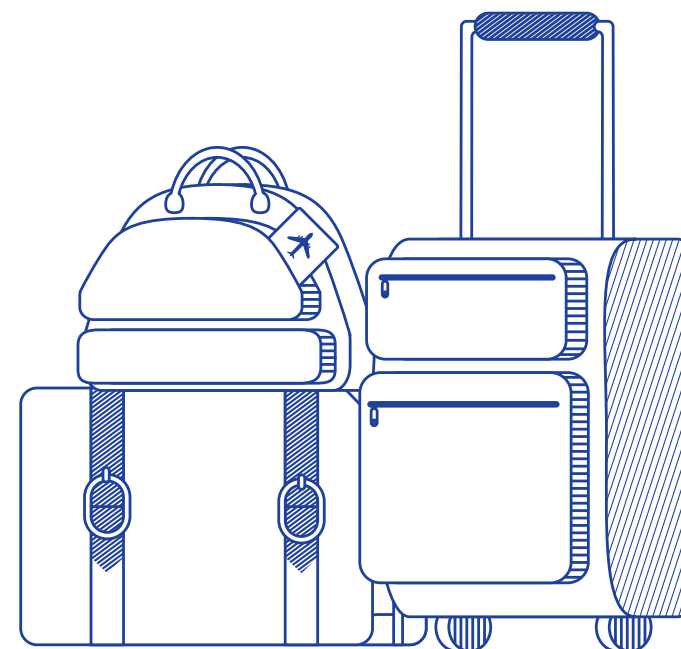

Additionally, 1,550 international students took a course with academic credit at Tec de Monterrey:

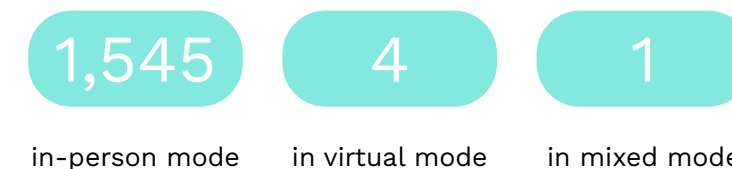

## SCHOLARSHIPS AND SUPPORT FUNDS FOR INTERNATIONALIZATION

21

students benefited from accommodation and transportation expenses in in-person mobility programs with the My International Experience Fund (FMEI) of the Garza La Güera Gonda family.

6

undergraduate students benefited from the CEAL-UAM-Santander-Tec Scholarship for academic experiences in Madrid, Spain.

## GLOBAL SHARED LEARNING:

The Global Shared Learning (GSL) initiative promotes collaboration between students, professors and international partner universities in a digital environment with the use of technological tools.

GSL Classroom allowed 7,395 undergraduate students and 7,021 international students to participate in 318 collaborative courses with 92 universities from different countries. As part of the same initiative, GSL Week benefited 1,144 undergraduate Tec students and 832 international students during Tec Week in 26 collaborative courses taught by 27 Tec Professors and 22 foreign professors from 7 partner universities in 5 countries.

## INTERNATIONAL POSITIONING

Tec students excelled in international events Universitas21

### ‘Celal-Mex’ project

by undergraduate students from Puebla Campus which received the “Greatest Impact” award in the Real Impact on Society and Environment (RISE) contest.

If you want to know more about the project, read it here:



### Project ‘Deciding a future’

by Juan Ramón Lara, student at the Mexico City Campus, received the Leaders of the Future award for social innovation.

If you want to know more about the project, read it here:



Two leadership programs were also offered for undergraduate students at Tec de Monterrey, one of them by U21 and the Common Purpose organization and the other by the Association of Pacific Rim Universities (APRU) consortium. The Global Citizens program has been offered for three years through U21 and in 2023 it granted microcredentials to 20 Tec de Monterrey students.

Tec participated as the host university for the 17th Annual Meeting of Vice-Chancellors of Administration and Finance of the Interuniversity Development Center (CINDA) consortium. Vice-rectors from 19 partner universities from 10 countries participated in this event. The presentations, panels and workshops focused on financing models for universities and digital transformation.

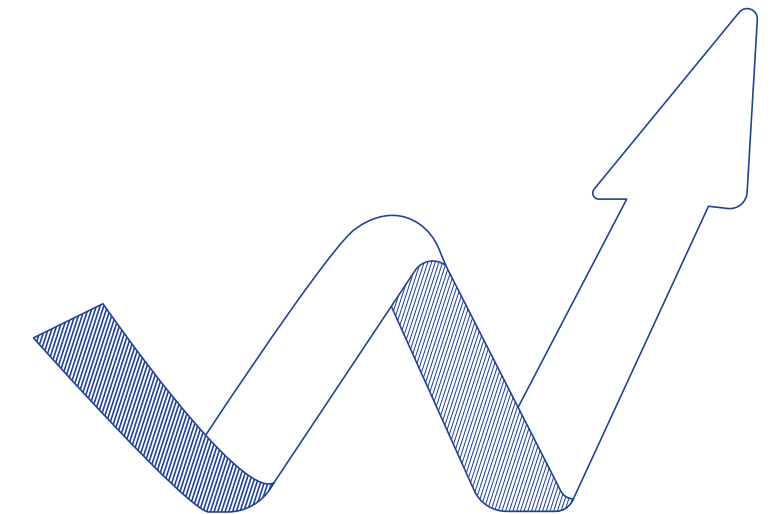





### iSummerMX 2023:

Academic-itinerant experience. The 2023 program began and closed at the Mexico City Campus. Additionally, the enrolled students had LiFE activities and cultural visits in the cities that host the rest of the international campuses: Querétaro, Guadalajara, Monterrey; as well as the Puebla Campus.

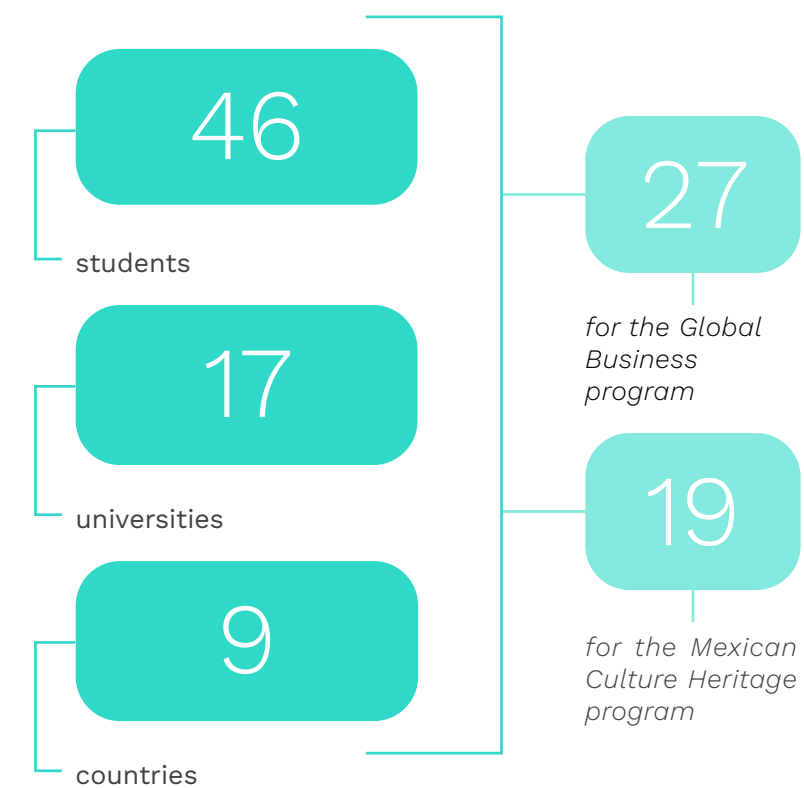

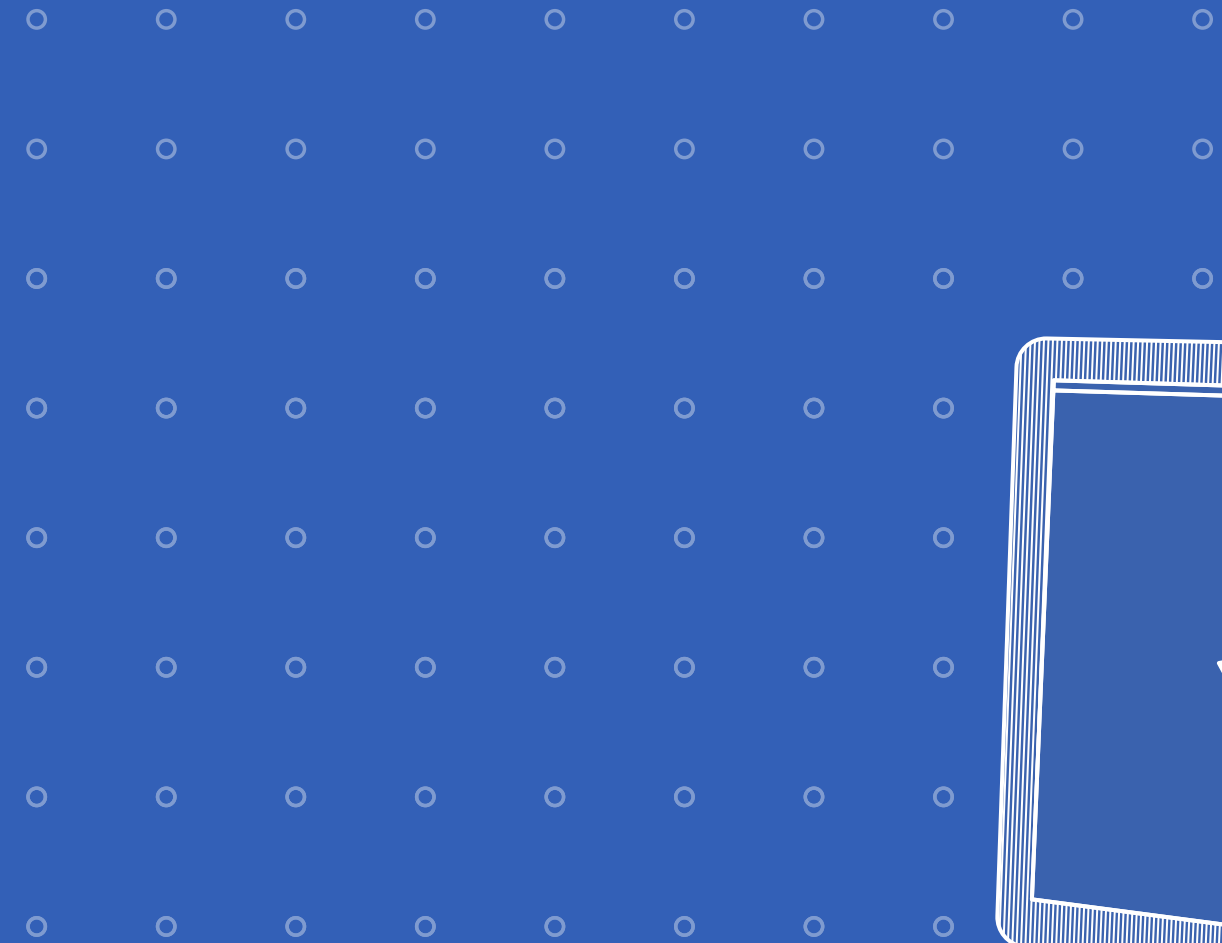

# Educational Innovation

# Educational Innovation

## EDUCATIONAL INNOVATION AND DIGITAL EDUCATION AT TEC DE MONTERREY

Tecnológico de Monterrey, with more than 35 years of experience in the use of technology for education, began in 2022 the definition of a new institutional strategy for Digital Education. During 2023, the implementation of this strategy had a significant impact on the academic offer and continuing education:

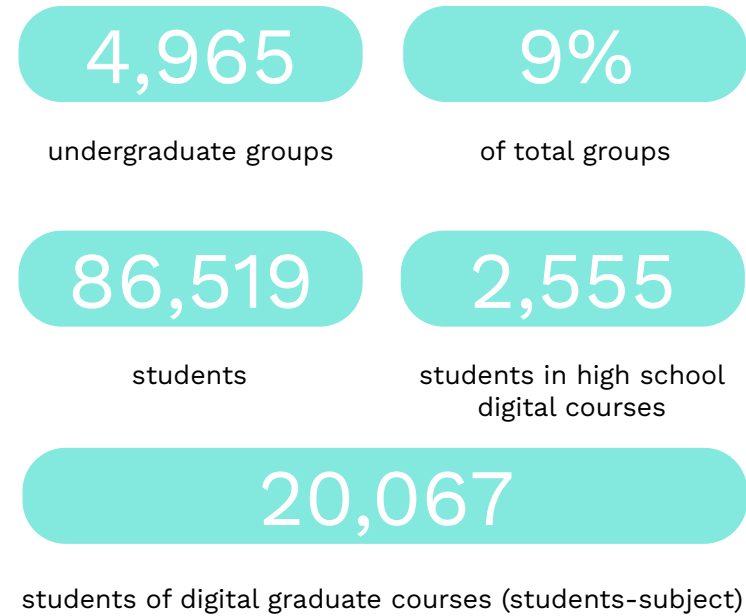

Pilots were carried out to incorporate techno-pedagogical innovations in the academic offer:

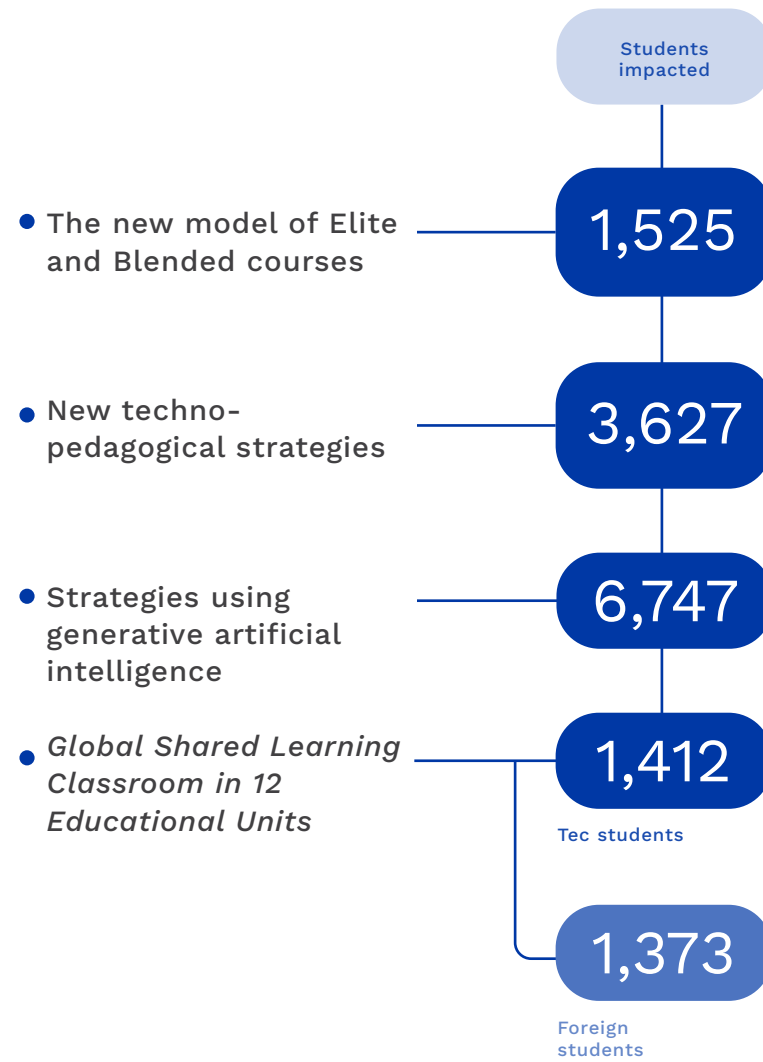

## DIGITAL LIBRARY AND MULTIFORMAT RESOURCES

The “Multiformat Digital Library” strategy was deployed with a new Library Portal.

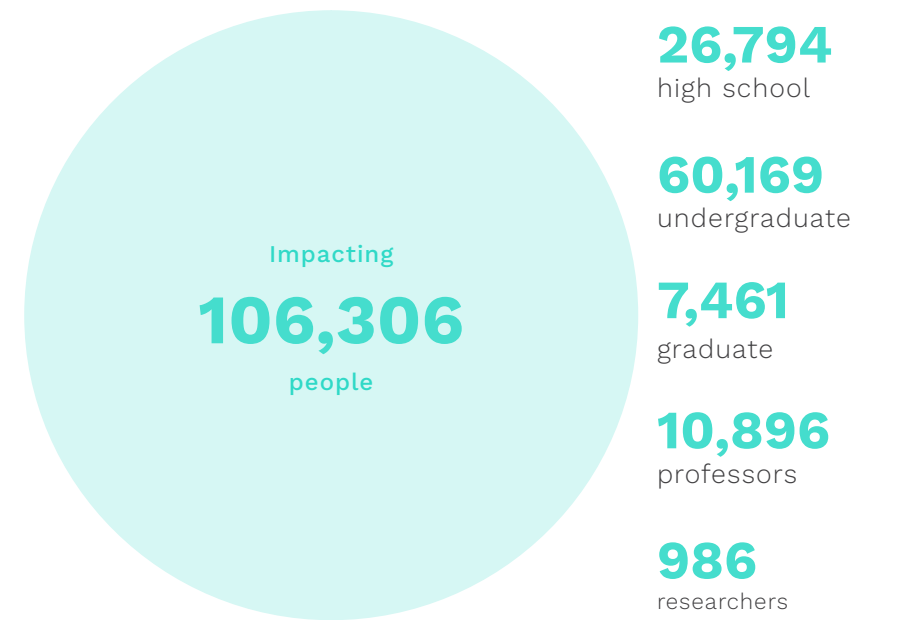



## TEACHING HUB AND VIDEOTEC

### Teaching Hub:

Portal with more than 300 pedagogical resources and for professors self-management, with more than 1,600 downloads and more than 2,900 accesses.

### VideoTec:

New digital video library with 5 collections and more than 930 videos.

The Educational Innovation channel on YouTube with more than:

40  
collections

1,800  
videos

+4,700  
subscribers

+1M  
views

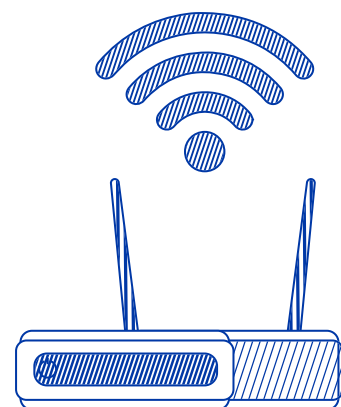

## INITIATIVES AND DRIVERS OF INNOVATIVE DIGITAL EDUCATIONAL EXPERIENCES

### 1. Adaptive Learning:



4 undergraduate Educational Units were taught with 59 professors from 13 campuses, impacting 1,116 students.

### 2. Immersive learning with extended reality



Implementation of immersive experiences.

Impact on 25,905 students and 936 professors in 410 in-person and digital Educational Units.

First Immersive Learning experience with mixed reality at the School of Dentistry.

### 3. Professor with hologram effect



Continuation of the Tec-TU Delft relationship for the exchange of classes with hologram effect.

Simultaneous transmission to 11 campuses, impacting 810 students and 54 educational units.

### 4. Hall Immersive Room



Teaching of 63 educational units at Campus Monterrey, impacting 5,950 students and 77 professors.

Design and installation of an immersive room in collaboration with the Guadalajara Campus, in Blended mode, as part of the space habitat of the EGAD building.



## 5. Certifications and publications

### Certifications:

Certification in Agile Project Management Skills obtained the ANCYPEL quality seal.

Launch of the first book on sustainability and 8 publications of papers related to AIRX experiences.

### Publications:

63 publications on best practices in digital learning experiences and educational innovation in Times Higher Education's Campus+ initiative.

45,338 unique views from 191 countries, with 18% more views than in 2022.

## TECHNOLOGIES FOR EDUCATION

### Educational technologies ecosystem

With the aim of keeping Tec at the forefront and aimed at improving the experience of the teaching-learning process, the following were evaluated:

46 educational technologies from 8 categories

11 were tested

6 of them soon to be implemented and integrated into the educational technology ecosystem

Some of the categories of these technologies are: Technologies for engagement, evaluation, integrity detection and competency management.

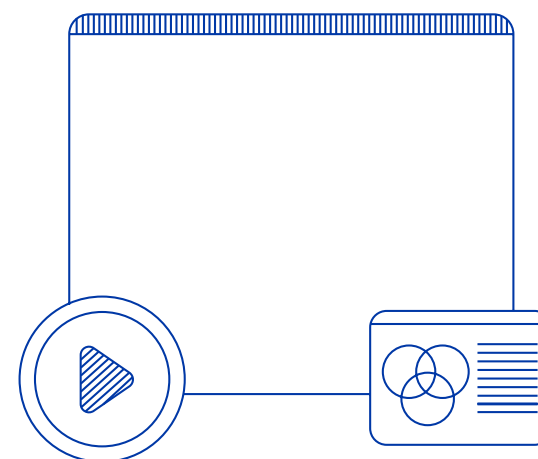

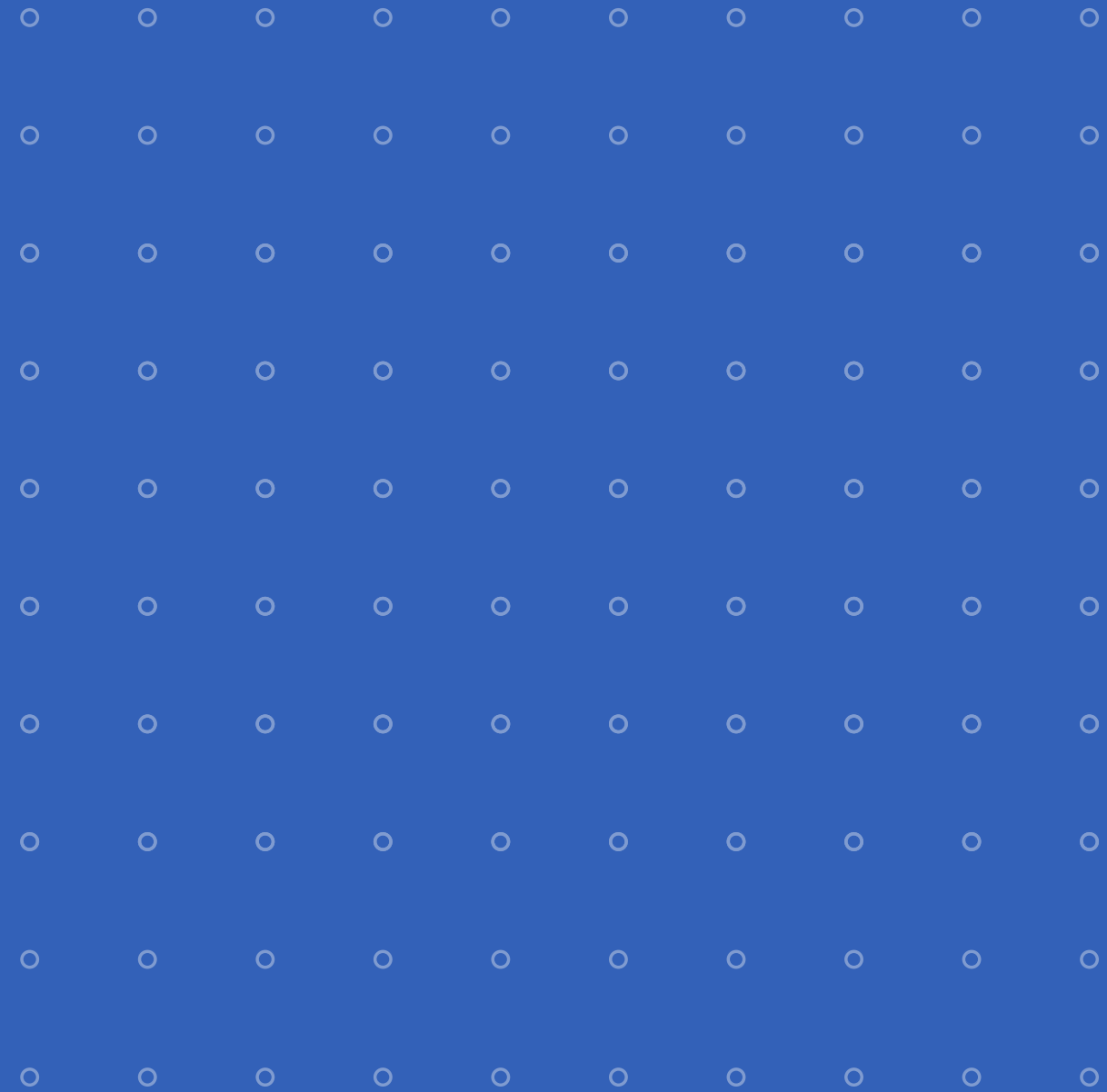

# Accreditations

# Institutional Accreditations

Tecnológico de Monterrey has these accreditations:

## INSTITUTIONAL ACCREDITATIONS:



### Federation of Private Mexican Institutions of Higher Education

Instance that in April 2022 reaffirmed the accreditation for the next seven years.



### Southern Association of Colleges and Schools Commission on Colleges

Currently, we're working on the 5th year Report with the next accreditation in 2028.

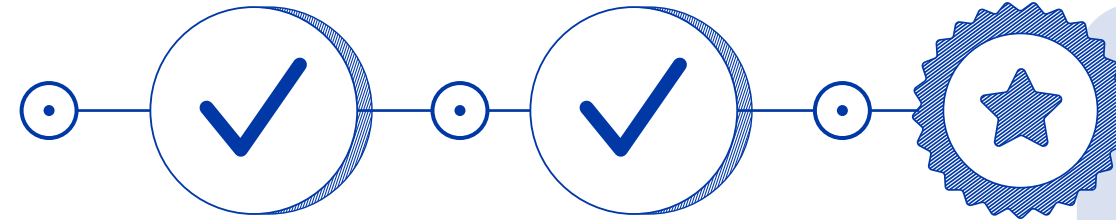

## ACADEMIC PROGRAMS ACCREDITATIONS:



### Accreditation Board for Engineering and Technology (ABET)

35 programs/Undergraduate campuses are accredited by the ABET.



### Association for Education in Journalism and Mass Communication

Department of Communication and Digital Media



### Board for Higher Education Accreditations

92 programs/Undergraduate campuses are accredited by recognized national agencies. (37 current and 55 in extension for 2019 plans).



### CONACYT's National Graduate Programs System

17 Graduate programs were recognized by CONACYT's National Graduate Programs System, with 7 programs in review.

### EGADE Business School

Obtained reaccreditation with AACSB for 5 more years, the maximum possible period.

With this, it maintains its position as part of the 1% of business schools worldwide that receive the Triple Crown of International Accreditations AMBA, AACSB and EQUIS.

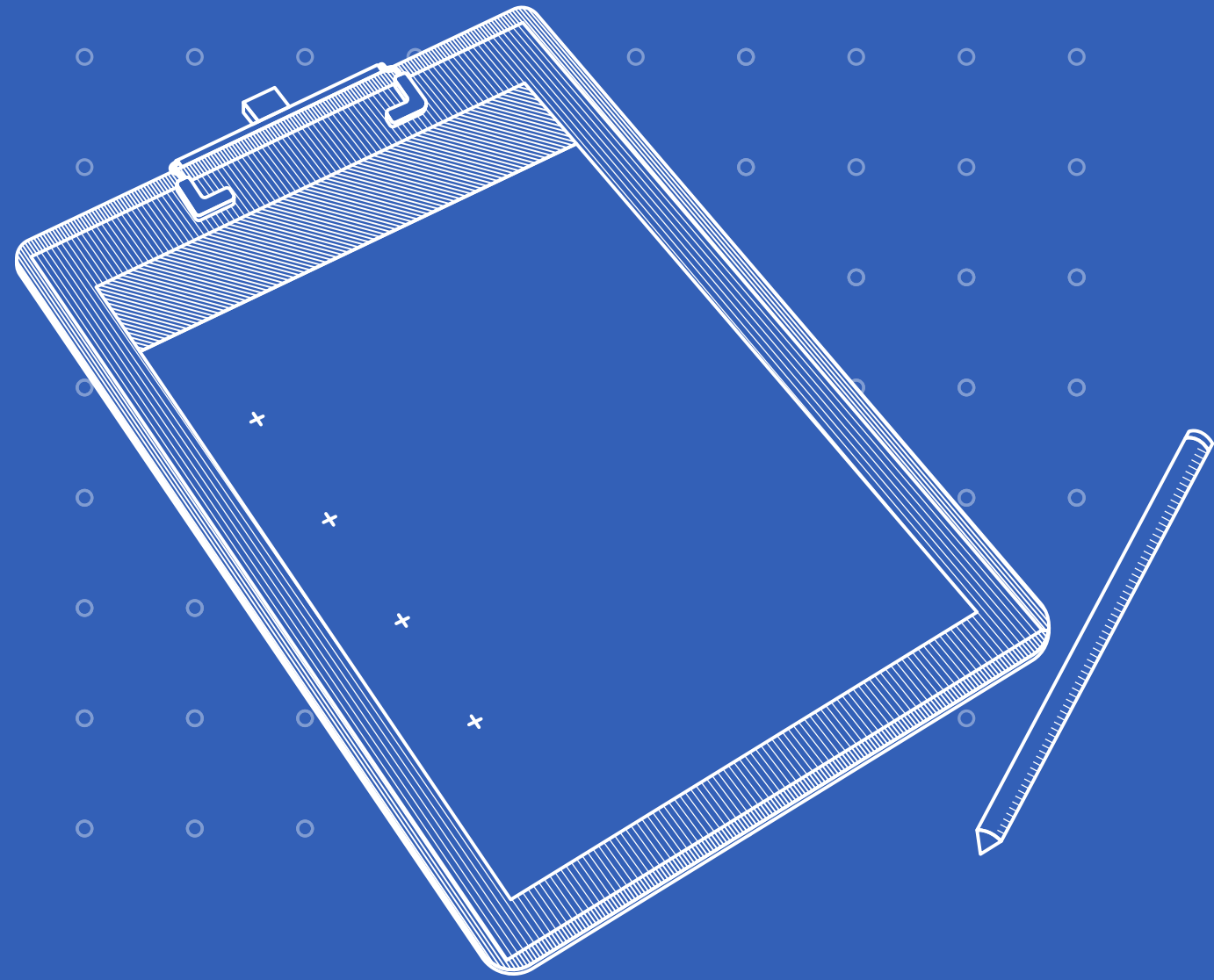

# Our National Schools



# Our National Schools

At Tecnológico de Monterrey, our reason for being is to provide quality education. Through our six National Schools, we lead efforts to improve programs and strengthen the faculty body to ensure excellent academic standards. Over the course of this year, the School of Architecture, Art and Design (EAAD), the School of Social Sciences and Government (ECSG), the School of Humanities and Education (EHE), the School of Engineering and Sciences (EIC), the School of Medicine and Health Sciences (EMCS) and the School of Business (EN) have focused on actions that support operational management, ensure quality implementation and promote disciplinary research.

In 2023, our National Schools are integrated as follows:

	Students per school		Faculty per school	
	Undergraduate	Graduate	Full time	Adjunct professor
Engineering and Sciences	22,508	3,152	880	1,594
Business	16,170	2,421	457	2,004
Architecture, Art and Design	6,163	40	190	714
Social Sciences and Government	3,524	239	172	691
Medicine and Health Sciences	3,073	519	162	897
Humanities and Education	2,493	562	180	744
<b>Total</b>	<b>54,762</b>	<b>6,992</b>	<b>2,041</b>	<b>6,644</b>
	(Includes 831 Special Students and International Programs)	(Includes 59 Special Students, DCS and International Programs)		

To consult the list of academic programs offered by Tec de Monterrey, consult the Appendices Section.

## SCHOOL OF ENGINEERING AND SCIENCES

Feniosky Peña-Mora was appointed as the new dean of the School of Engineering and Sciences. Feniosky brings global experience and an innovative vision, promising to strengthen academic excellence and the connection between industry and academia.



### Rankings

In the QS Ranking by Subject we excel in different areas with the following positions:

- Engineering & Technology **72**
- Computer Science & Information Systems **86**
- Engineering - Mechanical, Aeronautical & Manufacturing **104**
- Engineering - Civil & Structural **145**
- Agriculture & Forestry **182**

These achievements reflect a successful year for the EIC, marked by advances in leadership, positioning strategies, international collaborations, and awards in research and teaching.

### Strengthening of the School of Engineering and Sciences

Among the many initiatives and advances this year, the following stand out:

- Appointment of Julio Noriega as Associate Dean of Regional Coordination and Strategy to standardize efforts and activities.
- Launch of two National Leadership Programs to strengthen institutional leadership.
- The World Engineering Education Forum & Global Engineering Deans Council was held at Monterrey Campus, bringing together academic leaders from around the world. Positioning and International Linkage Plan Initiative.



- Matching Funds Program: joint financing program that helps facilitate collaboration between universities and external sources: University of Alberta, University of Ottawa, Higher Council for Scientific Research, generating 130 publications and 3 successful applications to external calls.

- We have sought to promote the annual attraction campaign with a strategic focus, incorporating local efforts to address regional challenges in the EIC, achieving growth of 4.8% this year in the PIN.



- Ingenia, an initiative that seeks to promote the STEM area among women, has been successful in inclusive programs, such as mentoring with more than 300 participants, including 240 students and 35 mentors. Also, Ingenia's national campaign has achieved visibility for more than 35 profiles of professors and students.

### Alliances

International mobility and double degree agreements were established with universities such as RICE, University of Texas at San Antonio and University of Twente.



## Awards

Faculty and students received several recognitions in outstanding competitions and awards.

### Faculty:

**Sergio Serna** (Monterrey Campus) National Prize for Sciences 2023.

**Ashutosh Sharma** (Querétaro Campus) received the Distinguished Scientist Award (Plant Biotechnology) 2023 from IMRF Indo Pacific Region.

**Feniosky Peña-Mora** (Monterrey Campus) received the ASCE President's Medal, Distinguished Member and first Latino to serve as president in his 170th year.

**Aurea Karina Ramírez** Aurea Karina Ramírez (Querétaro Campus) and Danay Carrillo (Guadalajara Campus) Winners of the Tec Women's Award 2023.

**María Luisa del Prado** (Mexico City Campus) Professor selected in "25 women in science" by 3M.

**Grissel Trujillo** (Monterrey Campus) Young Researcher Award from the Mexican Academy of Sciences 2023.

### Students

**Escudería E Racing** (Estado de México Campus) obtained first place in Latin America in the Shell Eco Marathon Americas 2023.



**Robotronics** (Saltillo Campus) 3 awards at the VEX Robotics World Championship.

**TM Racing team** 2nd place in the Formula Student UK 2023.

## EIC Research

The School of Engineering and Sciences has seen significant growth in scientific graduate courses, with 810 students and an increase of 11% in the last year. Scientific productivity is reflected in a 9% increase in publications.

### Achievements and advances of Hubs and Research Centers:

- Collaboration of the Artificial Intelligence Hub with leading institutions such as IBM and Google.
- Strategic alliances between the Cybersecurity Hub with Siemens and AWS, demonstrating its commitment to gender equality.

- The Data Science Hub has strengthened its international presence with collaborations with ASU and UTSA.
- The FEMSA Biotechnology Center has consolidated the NISB, attracting contracts for the development of biotechnology projects for more than 15 million pesos.
- The Water Center has stood out in projects such as updating the "Water Plan Nuevo León" and its participation in the "Morgenstadt Global Smart Cities Initiative" project.

## EIC research groups:

These groups demonstrate a constant commitment to excellence, innovation and a significant contribution to the advancement of knowledge in their respective areas of research.

Emerging Food Technologies and Nutraceuticals: promotes research in the food industry.

Molecular Bioengineering and Systems: devices based on molecular switches and microcarriers for the culture of adherent cells.

Nanosensors and Devices: Selected for the Global-X Challenge 2023 Call, this group seeks to advance in smart fibers and textiles.

Smart Supply Chain and Logistics: With more than 40 published articles, participates in international projects seeking to improve manufacturing processes.

Photonics and Quantum Systems: strengthens national and international connections in photonics and quantum systems.

Water Science and Technology: Winner of the COMEPO 2023 Award, it stands out for the quality of its research and the talent of its students.

Cyber Physical Systems: With the “Multirobot-system Laboratory (Robotarium),” it validates algorithms, attracts investments from industry and universities, and contributes to the training of specialized talent.

Research in Advanced Artificial Intelligence: Consolidating international collaborations, this group attracts funding for innovative projects in artificial intelligence.

Energy Conversion, Management and Storage: Leading the project “An Equitable, Affordable and Resilient Nationwide Energy System Transition” collaborates with renowned institutions, attracting funds and providing financial support for students and postdocs in decarbonization strategies.



## SCHOOL OF BUSINESS

The Tecnológico de Monterrey School of Business stands out as a model in comprehensive education and academic excellence in the business field, being a leader in business education.

### Rankings

#### QS World University Rankings by Subject 2023:

- Marketing: 20th worldwide.
- Administration and Business: 24th worldwide.
- Accounting and Finance: 92nd worldwide.
- In the QS Global MBA & Business Master’s Rankings 2024, EGADE Business School maintains its leadership for the seventh consecutive year in graduate business education in Mexico and Latin America.

- Full-Time MBA, Master’s Degree in Finance and Master’s Degree in Business Analytics - #1 in Mexico and Latin America.
- Master’s Degree in Business Analytics Ranked - #1 Globally for Return on Investment.
- EGADE Full-Time MBA - within the global Top 20 for entrepreneurship and career of alumni.
- The Master’s Degree in Finance is ranked in the Top 25 globally for Employability.

### Strengthening of the EN

Among the many initiatives, new projects and advances this year, the following stand out:

- Inauguration of Habitat Farmacias Guadalajara for the Future of Business: unique space in LATAM to boost business with strategic thinking, technology, data analysis and entrepreneurship, in collaboration with Corporativo FRAGUA and Telcel.
- Tec Business Summit: Event with 600 business leaders addressing “The humanization of hyper-connected organizations.”



- EXATEC Business Meeting: First edition on 10 campuses with panels of experts, networking activities and an attendance of 730 alumni.
- New academic programs: Start of the first generation of the Bachelor in Finance program on three campuses. Opening of the Master’s Degree in Business Analytics and launch of the Master’s Degree in Strategic Marketing in Santa Fe.
- Educational Innovation: EGADE implements 16 educational innovation initiatives, incorporating technology to strengthen the academic experience, such as interactive challenges with augmented reality and virtual reality application in the classroom.



- The role of business in society - Bimbo Challenge: Participation of +3,500 students in a situational analysis of Grupo Bimbo. Ciudad Juárez Campus winner with sustainability proposal.
- Global Case Competition 2023: Second edition with Xiaomi as a training partner. A Monterrey Campus team won with a proposal focused on sponsorship of national eSports teams.
- EGADE strategic projects and initiatives: Active participation in events and programs, including the presentation of proposals for the energy democratization of the country before the Energy Commission of the Chamber of Deputies of the Congress of the Union. And host of the 40th Annual BALAS Conference.

## Alliances

EGADE Business School joined the Global Research Alliance for Sustainable Finance and Investment, an international network of leading universities specialized in research and education in sustainable finance. Tec stands out as the only LATAM institution among the 24 educational institutions in this worldwide alliance.

EGADE joined the Graduate Management Admission Council, a global association that brings together the main graduate schools of management.

EGADE was once again selected as “Champion School” in the global program of Principles for Responsible Management Education of the United Nations Global Pact.

## Awards

Faculty and students received several recognitions in outstanding competitions and awards.

### Faculty:

**Bryan William Husted Corregan** (EGADE Monterrey) recognized by World’s Top 2% Scientists 2023 from Stanford University, recognized with the Nuevo León Prize for Science, Technology and Innovation in the Social Sciences and Humanities category and honored with the Cuervo-Cazurra and Newburry Award 2023, awarded by the AIB-LAC.

**Ajnesh Prasad** (EGADE Santa Fe) recognized by World’s Top 2% Scientists 2023 from Stanford University.

**Felipe Pérez** (Campus Querétaro) ratified as a member of the Advisory Committee of Strive Learning Network by BFA & Mastercard and advisor of the Advisory Council for Inclusive Green Finance initiatives for MSMEs project.

**Carlos Agredano González** (Querétaro Campus) winner of first place in Eduhack 2023 with the project “Engage the students post pandemic.”

**Romain Pouzou** (Querétaro Campus), finalist for the QS Reimagine Education Awards 2023, in the Innovation Business Education category, was also ratified as a mentor and project consultant for Unreasonable GOALS 2023.

**Ján Reháč**, national director of the entrepreneurship program, and Víctor Jiménez, director of the Entrepreneurship program at the Querétaro campus, received the gold distinction at the QS Reimagine Education Awards 2023, in the Innovation Business Education category.

**Yarid Ayala** (Santa Fe Campus) selected for the Editorial Fellowship program of the Journal of Applied Psychology.

**Javier Armando González** (Monterrey Campus) recognized as editor of the International Journal of Instruction.

**Shahid Bashir** (Estado de México Campus) participation as Session Chair and Keynote Speaker at the Interglobe Research Network International Conference in Kuala Lumpur, Malaysia.

**Rajagopal X** (EGADE Santa Fe) honored with the Award Pravasi Bharatiya Samman, the highest honor awarded by the Government of India to its citizens abroad.

### Students:

**Jorge Romo Andrade** (Aguascalientes Campus) Finalist in the Global Community Challenge of the University of Calgary. Winner of the Jasso Scholarship to study at Keio University, Japan. Winner of the University Mobility Scholarship to study at Copenhagen Business School, Denmark.

**Arantxa Azul Medina Acevedo** (Morelia Campus) Outstanding participation in the Global Student Innovation Challenge 2023 in New Orleans, USA. Third place with the HEXALIGHT project, a protective shield against hurricanes with comfort

**Karol Ivanna Aceves Flores** (León Campus) Representative of Tecnológico de Monterrey in the international competition RISE 2023. Development of the “Mi’Kobol” project, a digital platform to educate young people on sexual education issues.

### Research at the School of Business

There were 139 publications in indexed journals in Scopus. Attraction of 8.5 million pesos for research projects of our groups. Publication in different media of 162 articles in which our research professors and academics participated.

#### Ecosystem of Business School Centers

- Retail Center: The center met its revenue goals by offering programs and consulting. Reports were made on the behavior of the Mexican consumer at key events, generating impact in the retail sector and the media.
- Center for Conscious Companies: A notable presence was achieved with more than 6,900 participants in conferences, 56 people enrolled in executive education programs, and advice to 16 companies in consultancies and a transformation accelerator. “The Conscious Capitalists” podcast recorded more than +25,300 downloads in 2023.
- Digital Evolution Center: The center exceeded its income goal by 200% and promoted the development of entrepreneurs by collaborating with allies such as Amazon, Google and Microsoft in events with organizations such as “10,000 Women for Mexico” and “SME Conferences on Digital Transformation”.

- FAIR Center: The attraction of fintech projects in its FAIR Fintech Lab call increased by 80%, providing advice and support to participants.
- Institute of Business Families: IFEM (in Spanish) impacted more than 800 students and 100 professors with educational units and academic activities. In addition, more than 60,000 people used its digital products and more than 170 families participated in training programs such as Leading Business Families and Continuity in the Business Family.

## SCHOOL OF ARCHITECTURE, ART AND DESIGN

### Strengthening of the EAAD:

Among the many initiatives, new projects and advances this year, the following stand out:

- Official launch of the Futures Design Lab: offers innovation services guided by design in the research, innovation and entrepreneurship ecosystems, supporting companies, researchers and organizations.

[Learn more about the Futures Design Lab](#)

- Inauguration of the ACT Lab, a laboratory for research, creation and experimentation in art, science and technology.
- The Tec has participated in international and national forums, exhibiting innovative projects at key events such as the Venice Architecture

Biennale, exhibition at Autostadt in Wolfsburg, Mextrópolis, Mexico Design Week and others. eventos clave como la Bienal de Arquitectura de Venecia, exposición en Autostadt de Wolfsburg, Mextrópolis, Design Week México y otros.



- The Faculty of Excellence is enriched with the incorporation of Zaida Muxí and Peter Jones, strengthening the commitment of the Tec and the EAAD to academic excellence.

### Alliances

Tec has consolidated strategic alliances with the Building Information Modeling (BIM) Alliance, Task Group México and associations with French universities and Aalto University, reinforcing its position as an international leader.

## Awards

Faculty and students received several recognitions in outstanding competitions and awards.

### Faculty:

**Ryan Anders Whitney** (Mexico City Campus) received the Seminar Series Award from the Urban Studies Foundation (USF).

**Lilian Salazar Díaz** (Mexico City Campus) Undergraduate and Graduate Architecture Professor, distinguished in architectural accessibility and educational innovation projects. She published the book “Accesibilidad Arquitectónica, su aplicación al diseño de espacios.”

**Edgar Paul Martínez Ludert Muñoz de Cote** (Hermosillo Campus) Director of the MUTU project that links artisans with students for social entrepreneurship. Winner of funds for creative projects. He published a chapter of the book “Design for vulnerables” and an article in the magazine “Arte, entre paréntesis.”

**Alfredo Orozco Valenzuela** (Guadalajara Campus) Leader in the design of Educational Units for the new Master’s Degree in Arts and New Media. Designer of the Frame by Frame Animation concentration. Organizer of academic events, such as Master Class with Roger Olmos.

**Nuria Margarita Menchaca Brandan** selected as guest director at the Anney International 2023 Animation Film Festival for her short film “Dalia sigue aquí.”

### Students:

**Jorge Lozoya** (Monterrey Campus) Architecture student. Received the CENEVAL Award for Excellence Performance EGEL, national recognition for future Architecture graduates.

**Sandra Paola Cruz** (Monterrey Campus) Design student. Winner of the FRISA award in the “Sustainability” category in its 52nd edition for her outstanding project.

**Valeria Gómez Zúñiga** (Monterrey Campus) Animation and Digital Art student. Winner of the National Award for ‘Talent that Inspires’ at the 2023 VibrArt festival.

## Research

- Seminar Series Awards Project - Urban Studies Foundation: Series of seminars on circulation and mobility of urban models in LATAM with a focus on social urbanism, gender and alternative circuits.
- CONACYT Research Project: Focused on “Design for Vulnerables”, established the “Sierra Nombre de Dios” Participatory Socioecological Observatory. Initiative aimed at addressing challenges of sustainable development in arid/semi-arid areas.
- International scientific events: “IV Interdisciplinary Research Congress in Architecture, Design, City and Territory” in Chile. Outstanding participation in the Monterrey Hub of the international symposium “RSD12 Entangled in Emergence.”

## Research groups

- Sustainable Territorial Development: Focused on publications, faculty development and projects. Stands out for generating successful proposals for external funds. Presence of Rob Roggema as Faculty of Excellence in 2023.
- Advanced Design Processes for Sustainable Transformation: Emphasis on the development of proposals for external funds and expansion of scientific culture. Addition of Peter Jones as Faculty of Excellence in 2023.

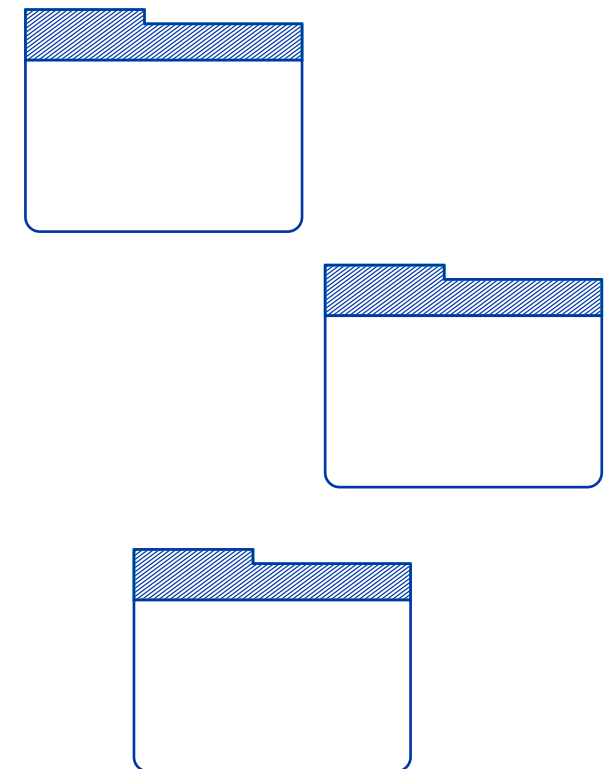

## SCHOOL OF SOCIAL SCIENCES AND GOVERNMENT

### Edna Jaime Treviño was appointed as the new Dean of the School of Social Sciences and Government.

Edna is a political scientist graduated from ITAM with more than 30 years of experience and stands out for her work in civil society, being the founder and former Director of México Evalúa. Her track record in public policy transformations will strengthen Tec's commitment to academic excellence.



## Strengthening of the ECSG

Among the many initiatives, new projects and advances this year, the following stand out:

- Culmination of three significant projects focused on critical interventions for disadvantaged communities in the Reach Alliance Initiative. These projects address the resilience of indigenous migrant communities, the appropriation of public spaces from a gender perspective and the invisibility of children with cognitive disabilities in marginalized communities.
- Recognizing and Supporting Student Leadership: The Transformative Talent Scholarship was established in 2023, benefiting 15 outstanding students.
- Extensive collaboration with the Nuevo León Government on various projects, including the making of the mental health diagnosis.
- Participation in prominent events such as the "Metropolitan Forum of Civic Justice" and the "Seminar for the Generation of Local Public Value" evidencing Tec's commitment to continuous improvement and strengthening of capacities in the public sphere.



## Awards

La Faculty y students recibieron varios Awards en competiciones y premios destacados.

### Faculty:

**María Gabriela Siller Pagaza** (Monterrey Campus) Recognized as one of the 20 most influential economists in Mexico by Forbes Mexico.

**Daniel Ricardo Lemus Delgado** (Guadalajara Campus) Appointed member of the Mexican Academy of Sciences.

### Students:

**Emilio Conde Pérez:** Winner of the Aztec Data Summit 2023 and data analyst at Endeavor México.

**Liliana González Gómez:** World Champion of the speech category of the 2023 University Debate World Championship in Spanish.

**Georgina Martínez Gracida:** Winner of multiple awards, including the International Peace Prize and the Oaxaca State Youth Prize.





## Research

The research in the groups “Government and Public Entrepreneurship”, “Economies of the Future”, “Democracy and Global Affairs”, and “Legal Systems Innovation” stands out with 43 Scopus publications, 439 citations and 38 participations in prestigious conferences.

- Alexandra del Carmen Jima González (Puebla Campus) 1st place in Policy Paper contest on Feminist Foreign Policy in Latin America in collaboration with a student. Award granted by Nueva Política Exterior.
- Research Group “Economies of The Future”, 70% of its publications are in the 25% of most cited publications in their discipline in Scopus.
- Rocío García Díaz (Monterrey Campus), Adan Silverio Murillo (Mexico City Campus), Edgardo Arturo Ayala Gaytán (Monterrey Campus), Ismael Aguilar Barajas (Monterrey Campus) and José Jorge Mora Rivera (Mexico City Campus) Recognized at Tec Science Summit 2023 as part of the Top 30 research professors at the Tecnológico de Monterrey due to the impact of their scientific production, the number of citations in the last five years and the attraction of funds, according to their discipline.

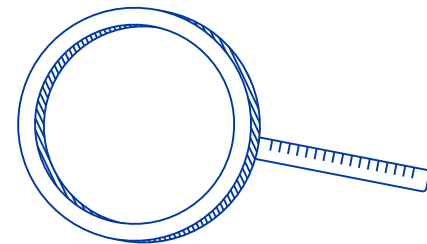

## SCHOOL OF GOVERNMENT AND PUBLIC TRANSFORMATION

The School of Government and Public Transformation celebrates two decades of educational leadership and significant contributions to the development of the country, highlighting its fundamental role in the education of public leaders in Mexico. **Miguel Angel Santos was appointed as the new Dean of the school.**



### Strengthening of the EGTP

Among the many initiatives, new projects and advances this year, the following stand out:

- Evolution of the Academic Offer: three innovative study programs were created during the first semester of the year: **Executive Master’s Degree in Public Administration**, aimed at professionals in the public sector. **Master’s Degree in Public Policy**, with specializations in various areas. **Master’s Degree in Data Science and Public Policy**, combining skills in data science and public policy.

- Specialization Summers: Hosting the DMDU Summer School for the second consecutive year, attracting international students and professionals.
- A Visualization in Data Science course was offered in collaboration with the Stevens Institute of Technology.
- Organization of the ICRS Conference in collaboration with global institutions such as the 4TU Centre for Resilience Engineering and the Singapore-ETH Centre, presenting research on infrastructure, urban development, energy and social media. Participation of more than 80 international experts and professors sharing knowledge.



### Awards

The faculty received recognition in outstanding competitions and awards.

#### Faculty:

**Edmundo Molina Pérez** (Monterrey Campus) received the Pardee RAND Rising-Star Award for his impact in less than 10 years after his Ph.D. graduation.

## Research

Featured projects:

- Modeling of Transportation Scenarios in Monterrey in collaboration with the University of Toronto Transportation Research Institute, using an agent-based simulator.
- Research on Employability Gaps in collaboration with the Inter-American Development Bank and the Nuevo León Council, addressing employability gaps in young graduates of high school education.

## SCHOOL OF HUMANITIES AND EDUCATION

The School of Humanities and Education, committed to comprehensive education, stands out in 2023 for its interdisciplinary approach, promoting equality and creativity with a gender perspective.

### Strengthening of the EHE

Among the many initiatives, new projects and advances this year, the following stand out:

- Education for Sustainable Development: Focus on cultural analytics and digital humanities to create new digital narratives that drive innovation, research and entrepreneurship.
- Participation in the Monterrey International Book Fair: 282,949 visitors to the fairgrounds in 607 events of the cultural program during the 9 days. 2,558 participants in 35 activities for 19 High School

and Undergraduate Tec campuses. 82,022 participants in 1,094 activities in the childhood pavilion. 14,658 participants in 94 middle schools in the youth program. Alfonso Reyes and Vaso Roto awards ceremony for the first time at the FIL Monterrey.



- Tec de Monterrey Short Film Festival: second edition of the festival highlighting student creativity. Presence of Miguel Mier, COO of Cinepolis, as guest of honor. Recognition of the filmmaker Lucía Gajá with the award for cinematographic career.
- Direction of Cultural Development: Carrying out 52 activities with more than 25,200 attendees. Participation in international events such as the Guadalajara International Book Fair.

### Awards

The faculty received recognition in outstanding competitions and awards.

**Paola Ricaurte Quijano** (Mexico City Campus) appointed representative of the Mexican government in the committee of experts in the Global Alliance for Artificial Intelligence (GPAI) and part of the committee of High Level Experts for the implementation of the Ethical Recommendation of AI of the UNESCO.

**María Robertha Leal Isida** (Monterrey Campus) appointed vice president of the Latin American Network of Writing Centers and Programs for the period 2023-2025.

## Research

The EHE's academic production has achieved notable achievements:

- Two books indexed in Scopus: "Gender-Based Violence in Mexico: Narratives, the State and Emancipations" by Francisco Díaz Estrada and "What AI can do" by Manuel Cebal-Loureda.
- "En-Claves del Pensamiento" Magazine: Indexed in Scopus, it went from level Q4 to Q3, being the only Scopus research magazine generated and produced at Tec de Monterrey for two consecutive years.
- Scopus articles: With a cut-off date of October 2023, there are 93 Scopus articles published, reaching 78% of the 120 goal.

The EHE leads several active research projects, highlighting:

- Challenge-based Research Funding Program: Three national projects led by EHE researchers, addressing topics such as "Cultural Heritage and Symbolic Capital," "Neurohumanities Laboratory," and "Evaluation of the effects of universal learning design strategies to create inclusive classrooms in the Faculty of Medicine."



- International Projects at Novus Triada: Collaboration with the Universidad de los Andes (Colombia) and the Universidad Católica de Chile in projects such as “Citizen Laboratory for the development of skills for global citizenship” and “Collaborative learning platform for the promotion and the development of innovative pedagogical practices.”

The EHE stands out in projects with external funds, including collaborations with the Inter-American Development Bank, the National Council of Humanities, Sciences and Technology, and the Secretariat of Education of Nuevo León.

The EHE has three solid research groups:

- Educational innovation:** With 3 researchers at 50%, 2 researchers at 25%, 1 Postdoc and 11 SNI.
- Digital humanities:** With 11 researchers at 50%, 3 researchers at 25%, 1 Postdoc and 9 SNI.
- Humanities for sustainable development:** With 2 researchers at 50%, 3 researchers at 25%, 1 Postdoc and 8 SNI.

## SCHOOL OF MEDICINE AND HEALTH SCIENCES

EMCS celebrated its 45th anniversary in November 2023 with commemorative events, including panels focused on inspiring the present, transforming the future and honoring the legacy, featuring alumni, former directors and deans. More than 300 members of the EMCS community in Monterrey attend the festivities.



### Rankings

The EMCS, with offices in Guadalajara, Mexico City and Monterrey, leads the National Examination for Medical Residency Applicants 2022, ranking in the Top 5 of universities with the highest scores and standing out as a model in private education focused on health.

### Strengthening of the EMCS

Among the many initiatives, new projects and advances this year, the following stand out:

- Educational innovation, the EMCS implements a pioneering project in Latin America within the Dental Surgeon Doctor program. Students can perform endodontics in a simulator with virtual support in real time through mixed reality and Hololens technology, without the presence of a professor.
- The EMCS Medical Surgeon Program in Monterrey and Mexico City obtains international accreditation from COMAEM for 5 years.
- Launch of the Clinical and Health Psychology program on the Chihuahua Campus, being the first time that a complete EMCS program is offered on this campus.

### Awards

#### Faculty:

**Dr. Mirna Alejandra González** (Monterrey Campus), is selected by 3M in the third edition of the “25 women in Science: Latin America” for her significant scientific contribution.

**Dr. Adolfo Leyva Alvizo** (Monterrey Campus), is admitted as a Full Member of the Mexican Academy of Surgery, highlighting his leadership and contribution.

**Rocío Ortiz López** (Monterrey Campus) recognized by the National Academy of Medicine of Mexico.

**Alejandro García González** (Guadalajara Campus) recognized with the State Prize for Innovation, Science and Technology.

**Mirna Alejandra González González** (Monterrey Campus) selected in the 25 Women in Science Latin America 2023 initiative by the company 3M.

**Dr. Juan Gutiérrez Mejía**, director of the EMCS Medical Surgeon program in the Mexico City Region, is recognized by the Secretary of Foreign Affairs for his outstanding contribution to health.





**Faculty:**

EMCS students win gold in ReachSci at the University of Cambridge for a project based on glucometers, which will be published in a scientific journal in collaboration with the University of Cambridge. The outstanding students are **Karen Medina Rodríguez, Sofía Quezada Ramírez, Guillermo Negrete Gómez, Jahir Rodríguez Rivera, Oscar Gutiérrez Treviño and José González Rayas.**

**Research**

Tecnológico de Monterrey is proud of the achievements made by its research teams, reflecting their excellence in the scientific and academic field.

- Featured Publications and International Recognition: +100 published articles, some of which have been featured in renowned journals such as Nature, Nature Immunology, Immunity, Cell Reports and Journal of Clinical Investigation.
- Success in Extramural Competitive Financing: with an approximate amount of 600,000 under the direction of Dr. Celia González through FODECIJAL.
- The team with Alejandro García González, Gisela Hialita Sánchez Sosa, Luis Manuel Aparicio Romero and Ricardo Javier Díaz Domínguez is recognized with the 2023 Jalisco Innovation, Science and Technology Award. The INNERT 2.0 device, conceived as a “Microenvironment: portable sterile ambient device for outpatient procedures,” stands out for its innovative impact in the field of ophthalmology.

**Research groups**

These groups, comprised of professors, students and multidisciplinary teams, lead notable advances in crucial areas for scientific and technological development. Among the research groups that set the standard are:

- Diagnostic and Therapeutic Innovation in Chronic Degenerative Diseases
- Advanced Therapies in Ophthalmology and Visual Sciences
- Global Health and Emerging Diseases
- Breast Cancer Research
- Developmental Biology and Comprehensive Wellbeing in Childhood
- Neurological Sciences and Neurorestoration

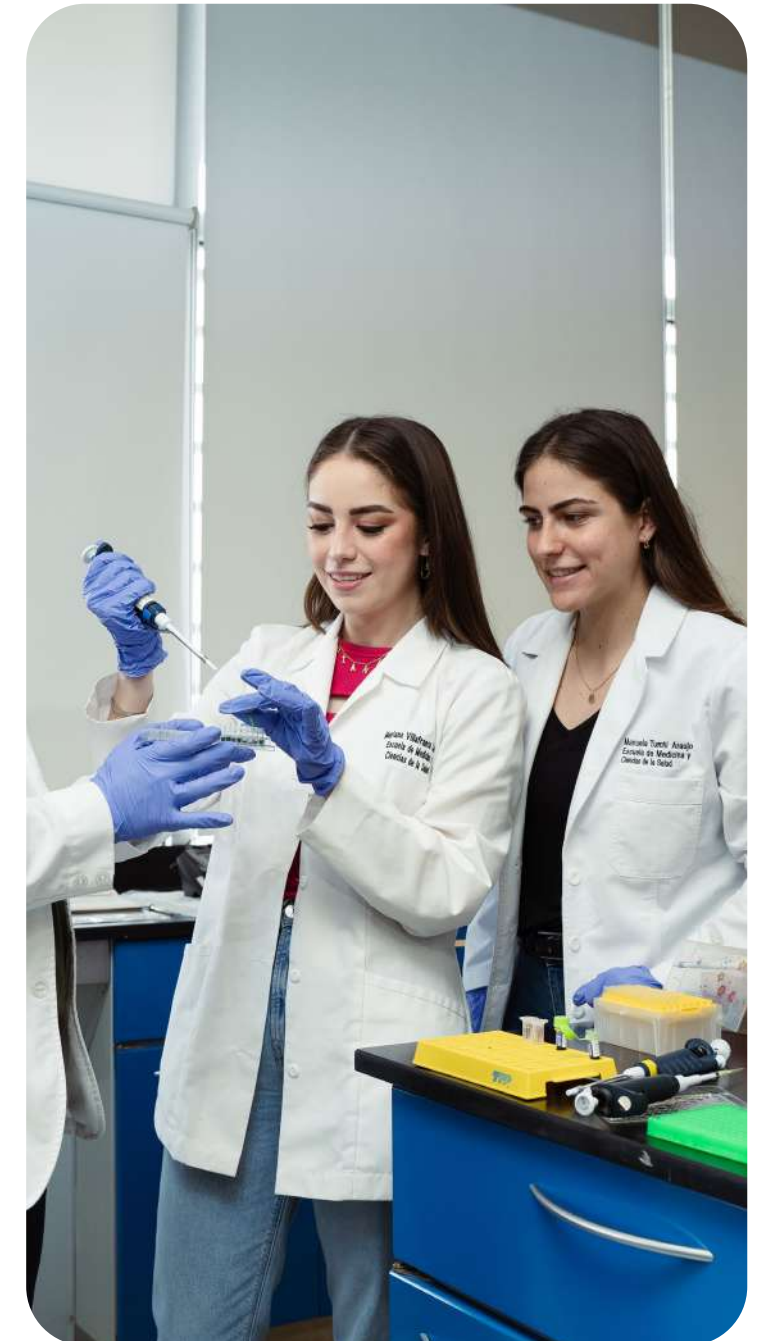



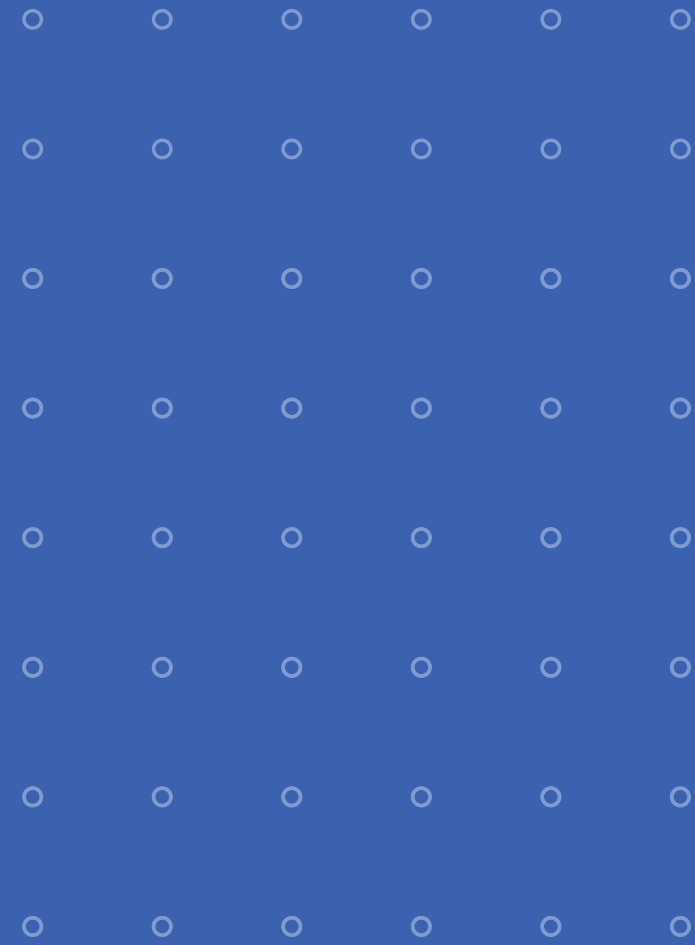

# Continuing Education

# Continuing Education

Through a flexible and personalized educational ecosystem, Tecnológico de Monterrey positively impacts more than 100,000 participants and 400 organizations, promoting human and professional development through reskilling, upskilling and networking.

**109,816**  
impacted participants

**409**  
organizations in collaboration

**913**  
Incompany projects

## Strengthening the Educational Ecosystem

The Learning Gate, Tecnológico de Monterrey's robust educational ecosystem, is strengthened with 6 thematic areas: Leadership, Data Science, Finance, Marketing & Sales, Project Management and Operational Excellence.

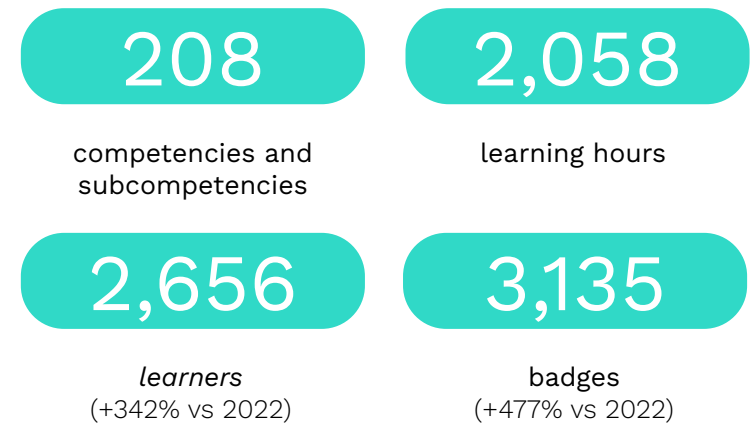

## ATTRACTING TALENT AND PROMOTING EXCELLENCE

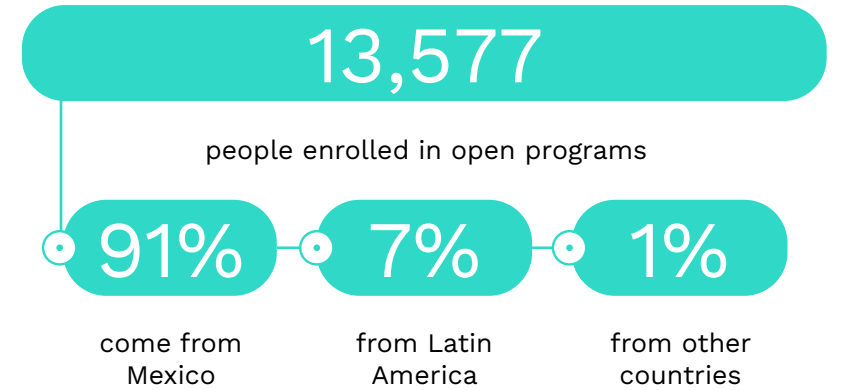
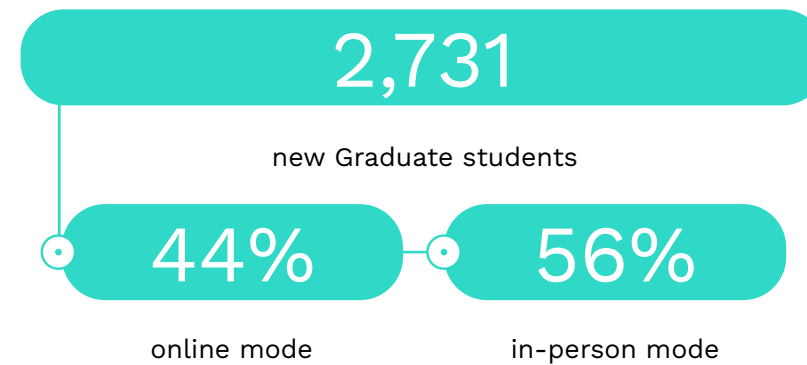

The digital Continuing Education offer was strengthened by including microcredentials, digital seminars and MOOCs.

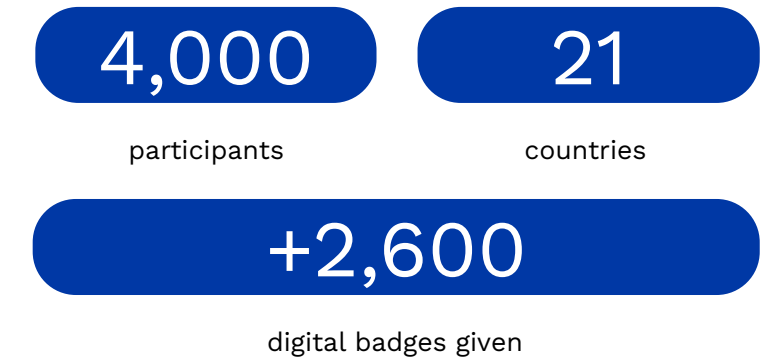

**+240,000**  
hours of Digital Catalog training

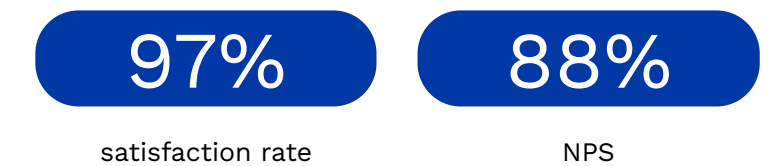

The teaching-learning model of digital programs is enriched by including techno-pedagogical trends such as: **100% immersive experience, HoloLens Technology, Artificial Intelligence - ChatGPT and TecBot.**

## Incompany Solutions: Transformative Impact on Organizations

85,898  
people

409  
companies benefited

913  
projects

This initiative significantly impacted 84% of the top 50 most important companies in Mexico, according to the EXPANSIÓN ranking.

Some initiatives during the year were:

- In **Diversity and Inclusion** topics, we managed to impact **23 organizations, through 33 projects.**
- We designed **Green Academy and its sustainability portfolio** through 3 lines: green business, green program, and climate readiness program, impacting 8 companies through 10 projects.
- **We expanded our operations to Brazil, Chile, Costa Rica and the Dominican Republic.** With this, 17% of our projects for organizations are outside of Mexico.

## STRATEGIC ALLIANCES: Global collaborations for success

Tecnológico de Monterrey strengthens its global presence through strategic alliances with prominent institutions and companies:

- IBM y Microsoft
- Red de Continuing Education para Latinoamérica y Europa (RECLA)
- Nuevo León 4.0
- KEY Instituto Kriete de Engineering and Sciences
- TecSalud, UManresa y Unión Consorcio Formación (Barcelona, España)
- SEMESP Brasil
- IBERDROLA
- Agencia Española de Cooperación Internacional para el Desarrollo (AECID)

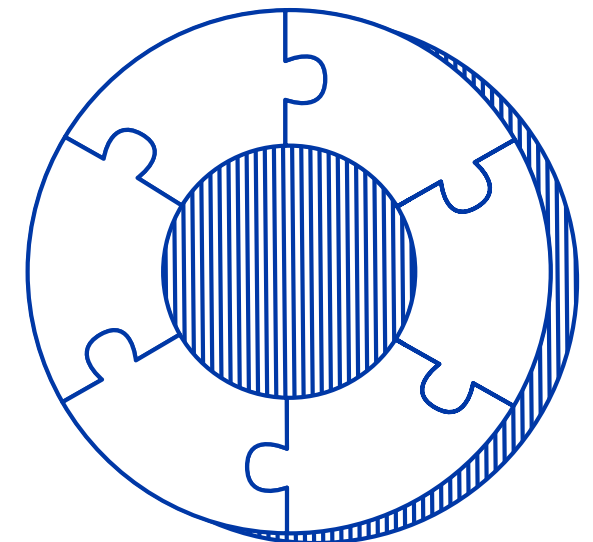

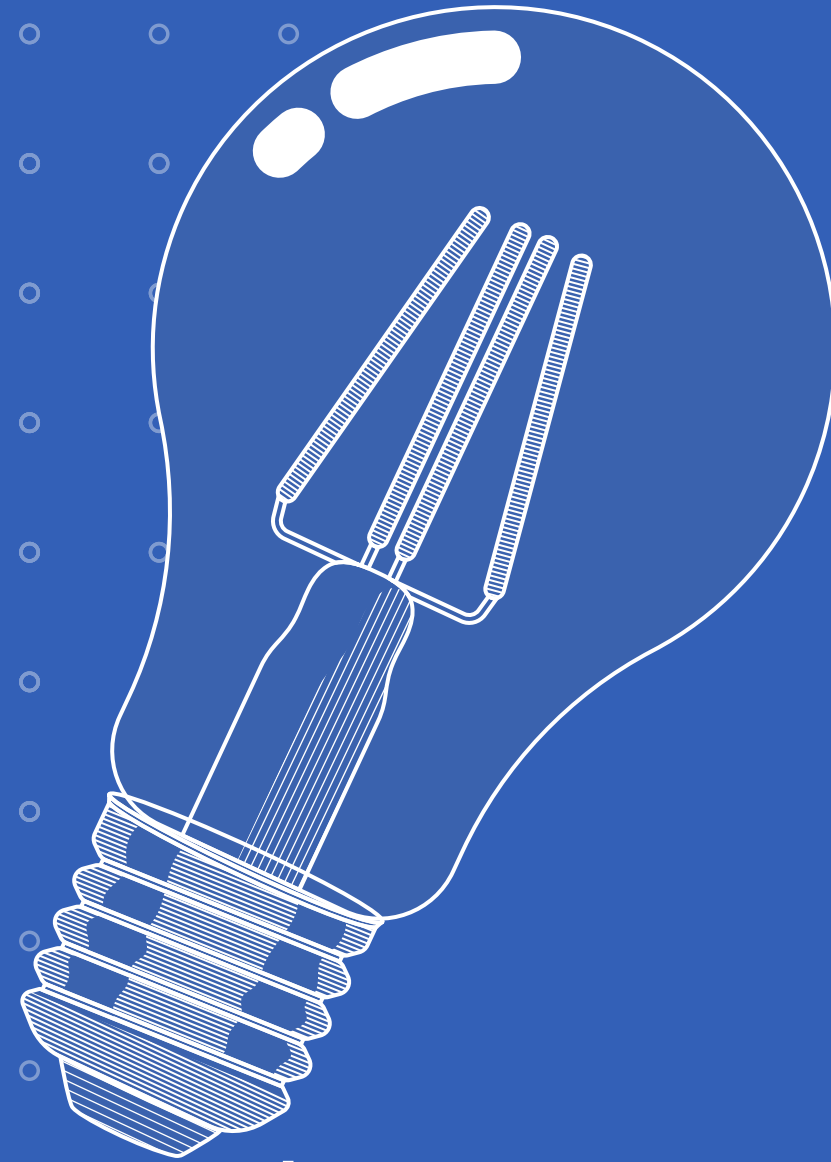

Entrepreneurship



# Entrepreneurship in Tec's DNA

The Eugenio Garza Lagüera Entrepreneurship Institute of the Tecnológico de Monterrey, after 11 years of operation, has experienced a transformation based on the model of agile organizations. We created:

## 4 Centers of Excellence

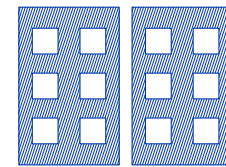

- Scientific and Technological Entrepreneurship
- Conscious Entrepreneurship
- Support for Business Development of SMEs
- Entrepreneurial Capital Training

**Top 10** in the Ranking of Universities with Undergraduate Entrepreneurship Programs by Princeton Review & Entrepreneur Magazine, currently on the position



#1

in the International Universities category



#6

in the global ranking.

The global consortium **“Babson Collaborative”** has awarded Tec de Monterrey the **“Circle of Influence”** recognition for its impact on educational strategies and boost of entrepreneurship in universities around the world.

## Entrepreneurial Training

12,587

students participated in academic entrepreneurship programs

1,711

students benefited from academic programs who seek to create a company during their academic studies

5,757

undergraduate students benefited in the different schools with the offer of 13 educational units focused on entrepreneurship

4,000

PrepaTec students served by “EmprendeLab”.

185

students benefited by the Scholarship for Entrepreneurial Talent, that reached it's 4th generation

## Initiatives to Boost Startups and Entrepreneurs

High-impact entrepreneurship programs were implemented, benefiting 3,000 students with co-curricular experiences:

### Freeland

workshops for future independent professionals with:

410

participants

18

campuses

### Explora Lab

an early validation program with:

356

students

18

campuses

### Venture Labs

an incubation program in sprint format with:

60

students

13

campuses

Offers to boost external startups:

**TPrize Venture Lab**  
to accompany the  
LATAM startups that  
won TPrize 2022

5  
startups

**Santander X Foundry  
Team incMTY**  
for high-level  
entrepreneurs

20  
startups

**PASIA 3.0**  
an acceleration  
program for artificial  
intelligence startups.

5  
startups

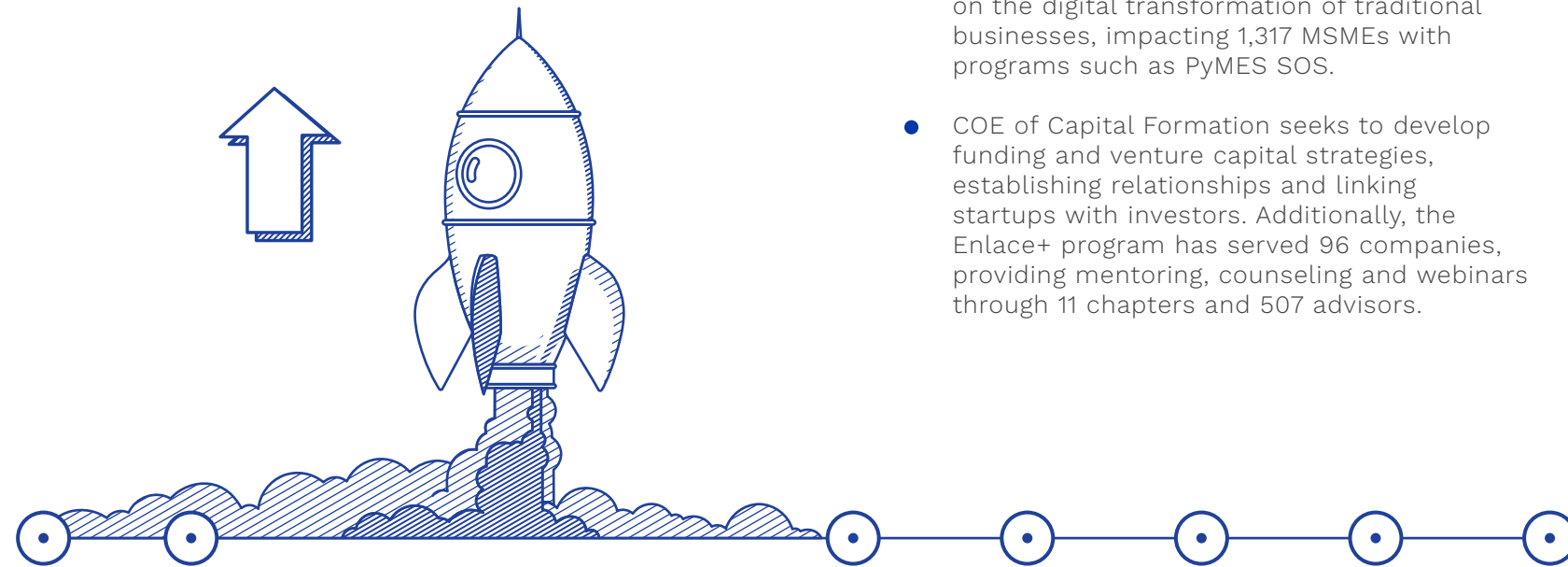

## Centers of Excellence (COE) and Mentoring Programs

Tec de Monterrey has established several Centers of Excellence to boost various facets of entrepreneurship:

- COE of Scientific and Technological Based Entrepreneurship focuses on scientific-technological startups, launching 11 programs in 2023 and benefiting 366 startups, highlighting initiatives such as Engineering Pioneers and Heineken Acceleration Program.
- COE of Conscious Entrepreneurship seeks to create an ecosystem of conscious entrepreneurship in Mexico and Latin America, offering programs such as Semilla Consciente and Raíz Consciente, impacting 260 students.
- COE of SME Business Development focuses on the digital transformation of traditional businesses, impacting 1,317 MSMEs with programs such as PyMES SOS.
- COE of Capital Formation seeks to develop funding and venture capital strategies, establishing relationships and linking startups with investors. Additionally, the Enlace+ program has served 96 companies, providing mentoring, counseling and webinars through 11 chapters and 507 advisors.

## Boost of Ecosystems and Regions

Tec de Monterrey leads key initiatives to strengthen entrepreneurial ecosystems in various regions:

**incMTY**, in its eleventh edition with the theme “Future Now”, attracted more than +6,000 in-person attendees, offering 240 activities and featuring more than 350 national and international speakers. This event included challenges such as Airtech Challenge, HEINEKEN Green Challenge and incMTY Accelerator, with the participation of 650 startups.



**incMty Querétaro**, attracted more than 3,800 people with 78 activities and more than 100 speakers.

**MIT REAP**, dedicated to accelerating technological entrepreneurship ecosystems, was implemented on 5 campuses outside Monterrey: Chihuahua, Querétaro, Jalisco, Guanajuato and Mexico City.



## Research and Knowledge Development

During 2023, the Entrepreneurship and Innovation Thematic Area Group, led by Dr. Sascha Fürst, included the participation of

30

researchers

26

doctoral students

26

scientific products

Three significant international studies stand out:

- **GUESSS Global University Entrepreneurial Spirit Students Survey** focused on generating indicators on the entrepreneurial spirit of university students, with the participation of 58 Mexican universities in 2023.
- **GEM Global Entrepreneurship Monitor**, with 20 years of experience in Mexico, completed its 2023 study, which is expected to be published in the first quarter of 2024.
- **GED Global Ecosystem Dynamics**, affiliated to the MIT, presented its study on the entrepreneurship ecosystem of Mexico City, using a methodology based on data science to map entrepreneurial regions.

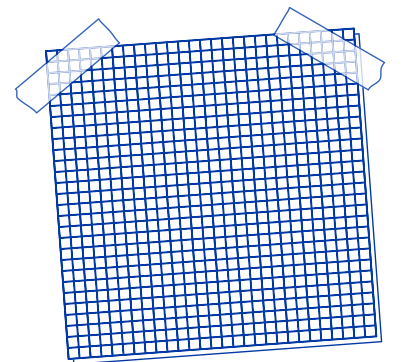
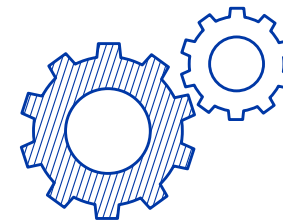
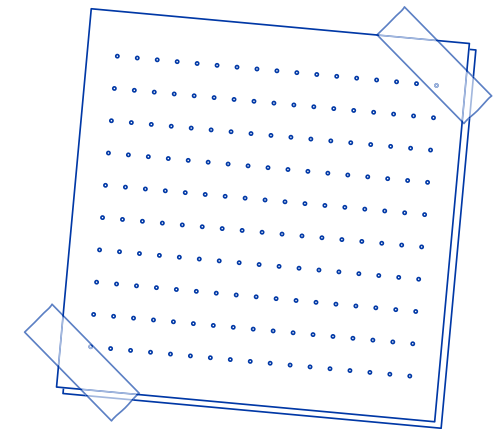
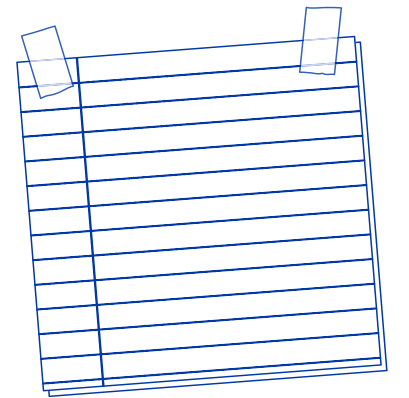

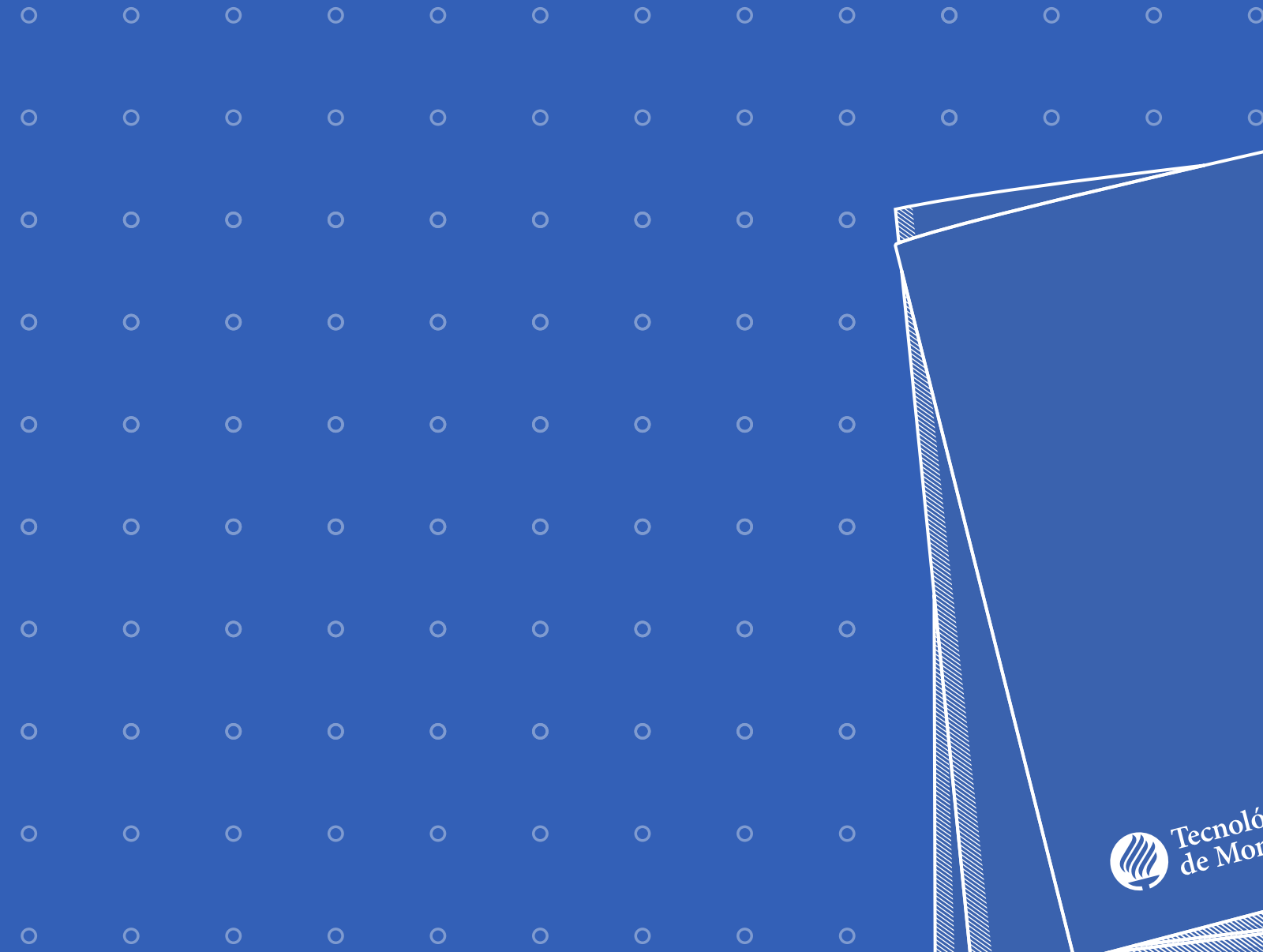

# Graduate Programs



# Graduate Programs

## PORTFOLIO DESIGNED UNDER THE NEW GRADUATE MODELS

In 2023, Tecnológico de Monterrey's graduate programs experienced a significant evolution towards new models, updating 12 academic programs of the School of Engineering and Sciences, EGADE Business School, School of Government and Public Transformation and School of Architecture, Art and Design with the Master's Degree in Art and New Media (MAM).

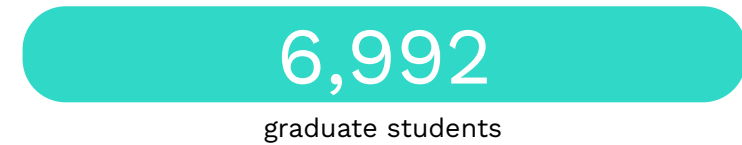

The focus is on the development of Transversal Paths, providing flexibility to students to enhance their professional profile. According to the Council of Graduate Schools, this guarantees employability or entrepreneurship. In this sense, Leadership that transcends, Professional development, Entrepreneurship, and Attraction of funds for research are the first launches that are in the pilot phase with:

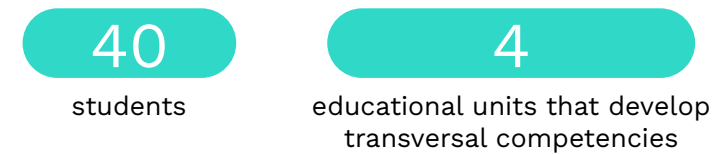

Likewise, the new model makes inter/transdisciplinary education a reality with Complementary Electives where a

shared offer between various graduate schools is deployed. Another innovation is Alternative Credentials which can be exchanged for graduate credits when certain requirements are met, recognizing the student's prior capabilities.

## STUDENTS

In the student sphere, the outstanding talent was manifested in the 36th National Graduate Congress (CNP) 2023, with the successful participation of **Jorge Estada** in the 3MT Competition and **Carolina Orona Navar** and **Juan Antonio Torre Martínez** in the COMEPO Prize for Doctorate Thesis.

### Student numbers

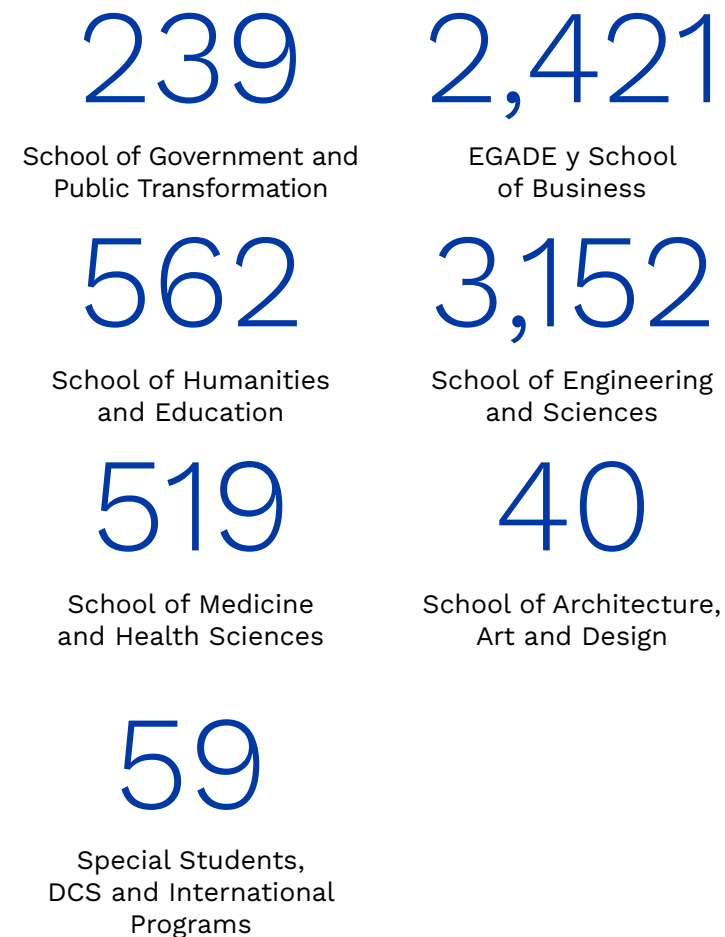

### Graduated students



### students graduated in 2023

During 2023, we offered

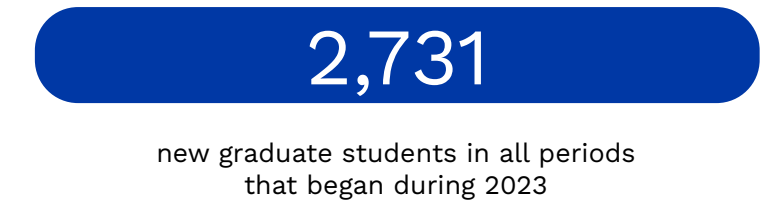
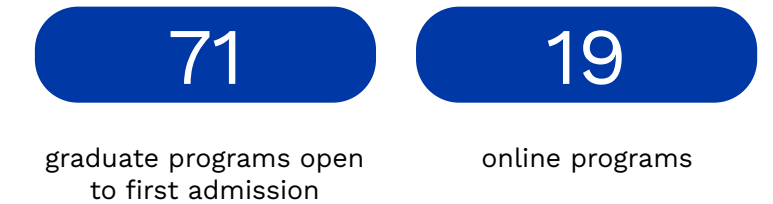

During 2023, 117 students graduated from graduate scientific programs. Each graduate completed a thesis whose research project belongs to one of the 46 Focus Groups or Research Units that have internal or external financing and in collaboration with some of the 20 most prestigious organizations or universities in Mexico or abroad. A total of 710 researchers with SNI recognition are part of the graduate educational ecosystem.



PrepaTec

# PrepaTec

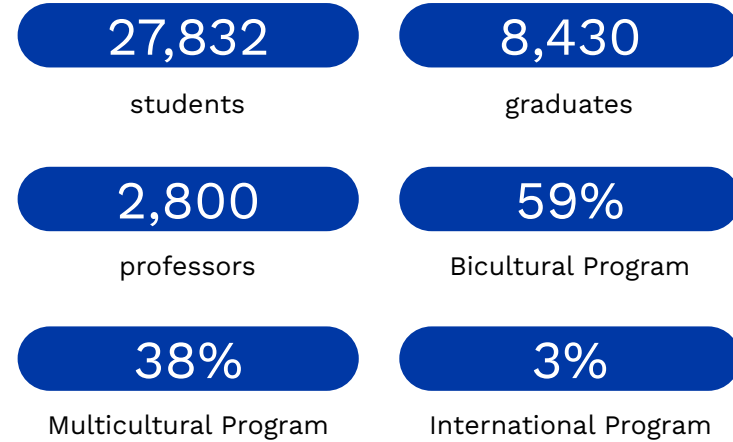

## ACADEMIC SPACES

PrepaTec students developed their educational and disciplinary competencies, through its courses and academic activities such as:

**+ 7,800**  
students participated in the PrepApps initiative, a National Entrepreneurship and Technology event.

**+ 8,000**  
students showed off the development of communication competencies at the PrepaTec Speeches event.

Within the Monterrey International Book Fair,  
**+1,000**  
students participated in the Juan Rulfo Literary Universe contest, +500 students participated in literary promotion activities.

**+8,300**  
PrepaTec students participated in the Leaders with Human Sense exhibition, an initiative that promotes awareness and development of Social Innovation.

## STRATEGIC AGREEMENTS

- PASCH initiative to boost the German language where 1,500 students and professors benefit from a resource platform and access to scholarships.
- National English Honor Society that enhances the development of our students in the English language: 15 PrepaTec, +230 students and 2 international awards.
- Generation Global to enhance the development of multicultural competence of our students. Impacting +9,000 students and +180 professors.

## ROAD TO COLLEGE

In August 2023, this initiative was deployed in the 34 high schools to accompany our students in their admission processes to the Tecnológico de Monterrey and the best foreign universities, assigning counselors to each of them.

## COMPREHENSIVE SUPPORT SYSTEM

Ensures the support of our students during their stay at PrepaTec so that through self-management they achieve their personal and academic development, strengthening

their competencies and promoting their wellbeing in the physical, emotional, social, intellectual and spiritual dimensions with actions such as:

**7D Radar**  
which seeks to help our students identify their development and improvement actions in the different dimensions of wellbeing.

**RULER Day**  
where +25,000 students participate each semester.

**Momentum**  
experience of reflection and presentation of the educational competencies where its +8,500 students participated.

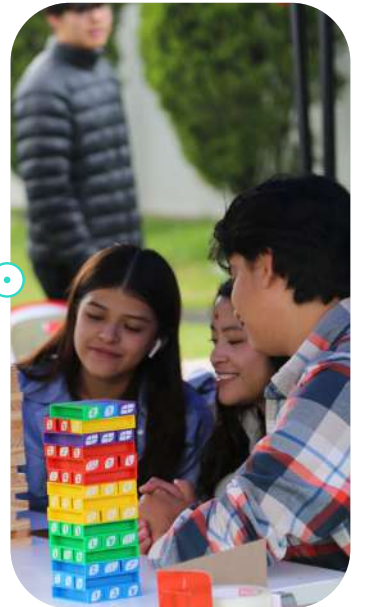

## INTERNATIONAL EXPERIENCE

Every year, students participate in **International Educational Experiences** in which, in addition to academic learning spaces, they strengthen their multicultural skills:

**4,605**  
students completed at least one international educational experience

**32%**  
semester experience

**68%**  
in short programs (summer or winter)



For the first time, an exchange agreement was signed with France, PrepaTec with the Auvergne-Rhône-Alpes region, which gives us access to a system of **+500 high schools for very accessible exchange options with comprehensive immersion experiences** for both the families that receive the students as in French schools and culture.

46%

of graduates had at least one international educational experience

95%

of the multicultural program

14%

of the bicultural program

29%

of the international program



329

accompanying professors

131

collaborative programs

67

foreign institutions

13

countries

3

continents





## EXPERIENCE, LEADERSHIP AND STUDENT EDUCATION

Enriching their integral development, the students participated in various LIFE activities:

### PrepaTec's Borregos:



**10**

Gold medals

**9**

Silver medals

**9**

Bronze medals

in the CONADEIP and ONEFA tournaments

**2,275**

students in the Inter-campus event

### PrepaTec's Art and Culture:

**25**

students performed at Disney California Adventure as part of the Broadway Imagination Campus

**+1,400**

participated in the national meeting of artistic disciplines, VibrArt

### Robotics competitions:



**7**

teams in the First Tech Challenge

**31**

teams in the First Robotics Competition

**9**

teams qualified for the World Cup in Houston

**1**

Silver medal in Engineering Innovation at FTC Global Singapore

**9**

international awards

**26**

national awards

### Students and Student Participation Councils:

**+50**

students participated in the FETEC Meeting event

### Coexistence and sense of belonging:

"UNO Day" welcomed about

**8,500 students**

**+8,000 students**

lived an experience of gratitude, introspection and coexistence on their last day of classes "MIL Day."



# LiFE: Leadership and Student Education

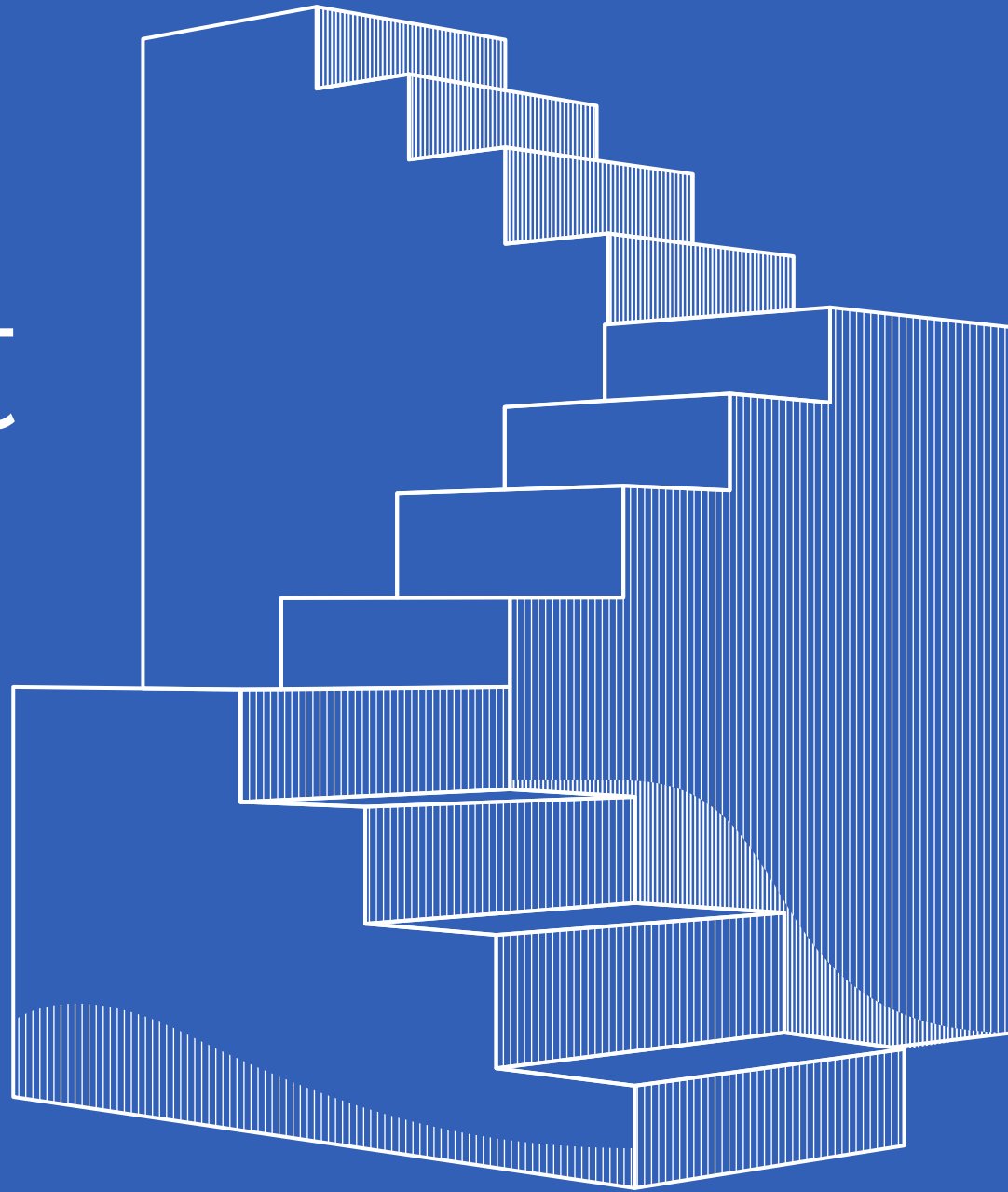

# LiFE

At Tecnológico de Monterrey we are committed to generating a memorable student experience through LiFE, with this, we contribute to the comprehensive education of our PrepaTec, Undergraduate and Graduate students.

Through its experiential and support model, LiFE is aimed at the student community to promote the discovery of their talents, the management of their emotions, foster leadership in their lives, generate social relationships with a positive meaning and impact on their environment.

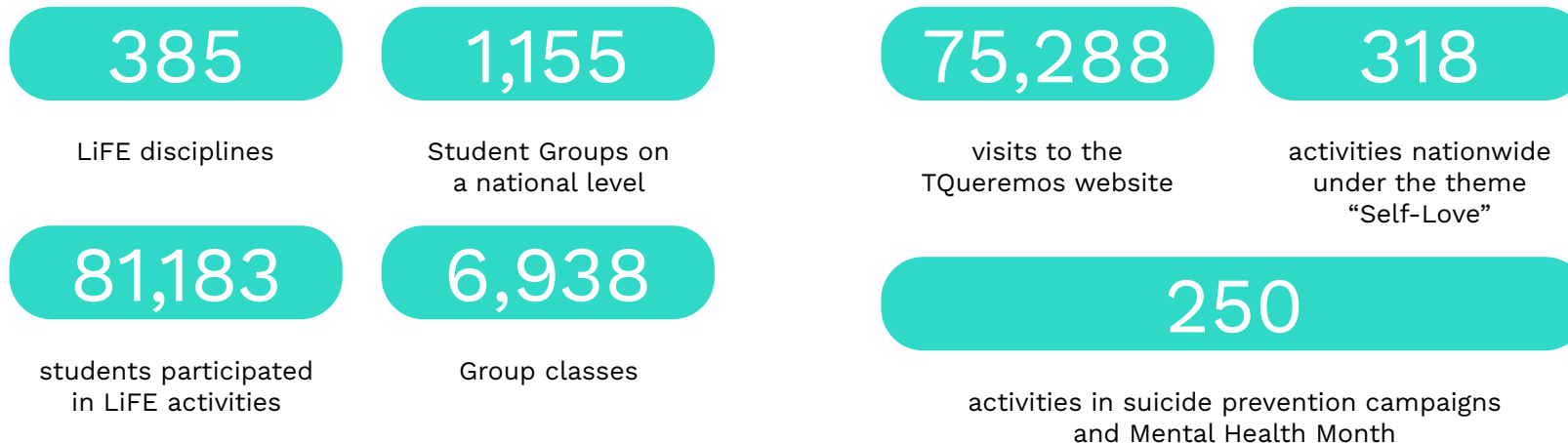

## STUDENT WELLBEING

Vocation of student wellbeing with a focus on comprehensive development. TQueremos and TQueremos Week promote spiritual, physical and emotional dimensions.



## ART AND CULTURE

### Classes and workshops

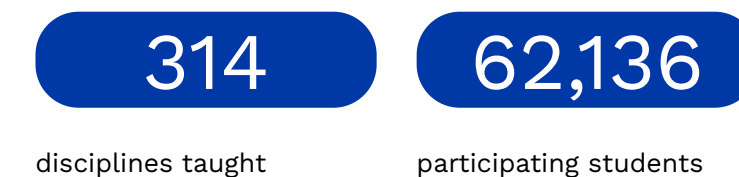

### Artistic companies

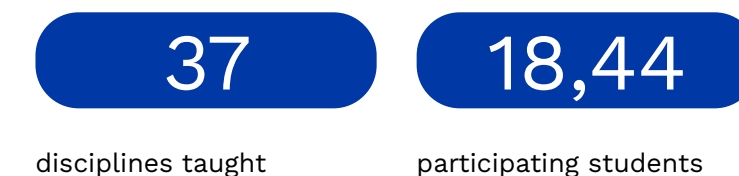

### VIBRART 2023

187% of views growth vs 2022.

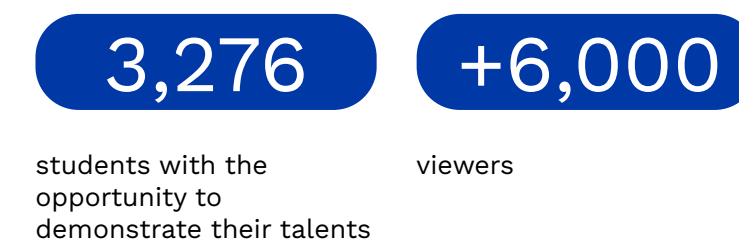



## SPORTING EXPERIENCE

### Mexican College Football Showcase

First ONEFA game in history to be held in the US that promotes Mexican collegiate football abroad, held on September 8, 2023 at the NRG Stadium of the Houston Texans.

### Flag Football Exhibition Match

Between the Santa Fe Campus women's representative team and the Ottawa University Braves, (+8 thousand attendees and +2.3 million viewers per broadcast in Mexico.)

### ONEFA Mayor

Borregos Monterrey won the two-time ONEFA championship 31-27 vs Auténticos Tigres de la UANL at the Gaspar Mass Stadium.



### 2023 National Universiade:

445 participating students from 12 campuses: 31 gold medals, 24 silver medals, 30 bronze medals.

### Sports Leagues

CONADEIP ABE: championships in basketball, soccer and volleyball, standing out in national and international competitions. 13 gold medals, 10 silver medals, 12 bronze medals.

### ABE League (Student Basketball Association):

Women's basketball: championship (Monterrey Campus) and runner-up (Estado de México Campus). Men's basketball: runner-up (Toluca Campus) and third place (Hidalgo Campus.)

### CUTT Telmex-Telcel University Championship:

Soccer: Monterrey Campus won the championship in both branches. Women's Indoor Volleyball champion Monterrey Campus, runner-up Chihuahua Campus and third place Estado de México Campus.

### ONEFA Youth Spring 2023

Monterrey Campus was champion and runner-up in three ONEFA Youth conferences.

### 2023 Pan American Games, Santiago de Chile:

Participation of 25 student and graduated athletes from different Campuses, obtaining 5 medals in disciplines such as Tae Kwon Do Forms (Individual / Couple), Sailing (women), Soccer (Women), Indoor Volleyball (Women).

## 2023 RECSPORTS AND ESPORTS

Outstanding participation in sports classes and intramural tournaments, impacting more than

# 71,000

students

eSports Fellowship program with:

34

participants

7

countries

11

universities

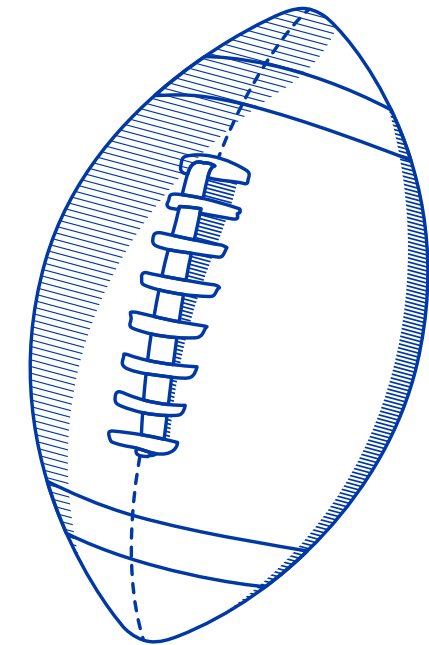



Inter-campus Borregos

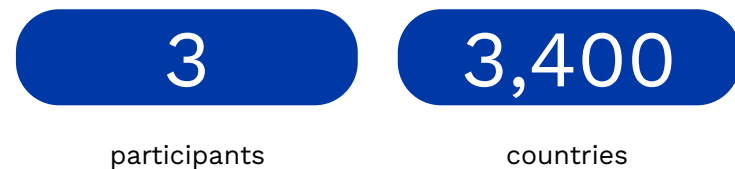

3,400  
students

The Eugenio Garza Sada Global Leadership Program developed the 2nd generation with 200 students.

## CAREER AND LIFE PLANNING CENTER

In 2023, the Tecnológico de Monterrey's Career and Life Planning Center implemented several initiatives to boost the employability of:

+15,000  
graduates

+85%  
employability rate three months after graduation

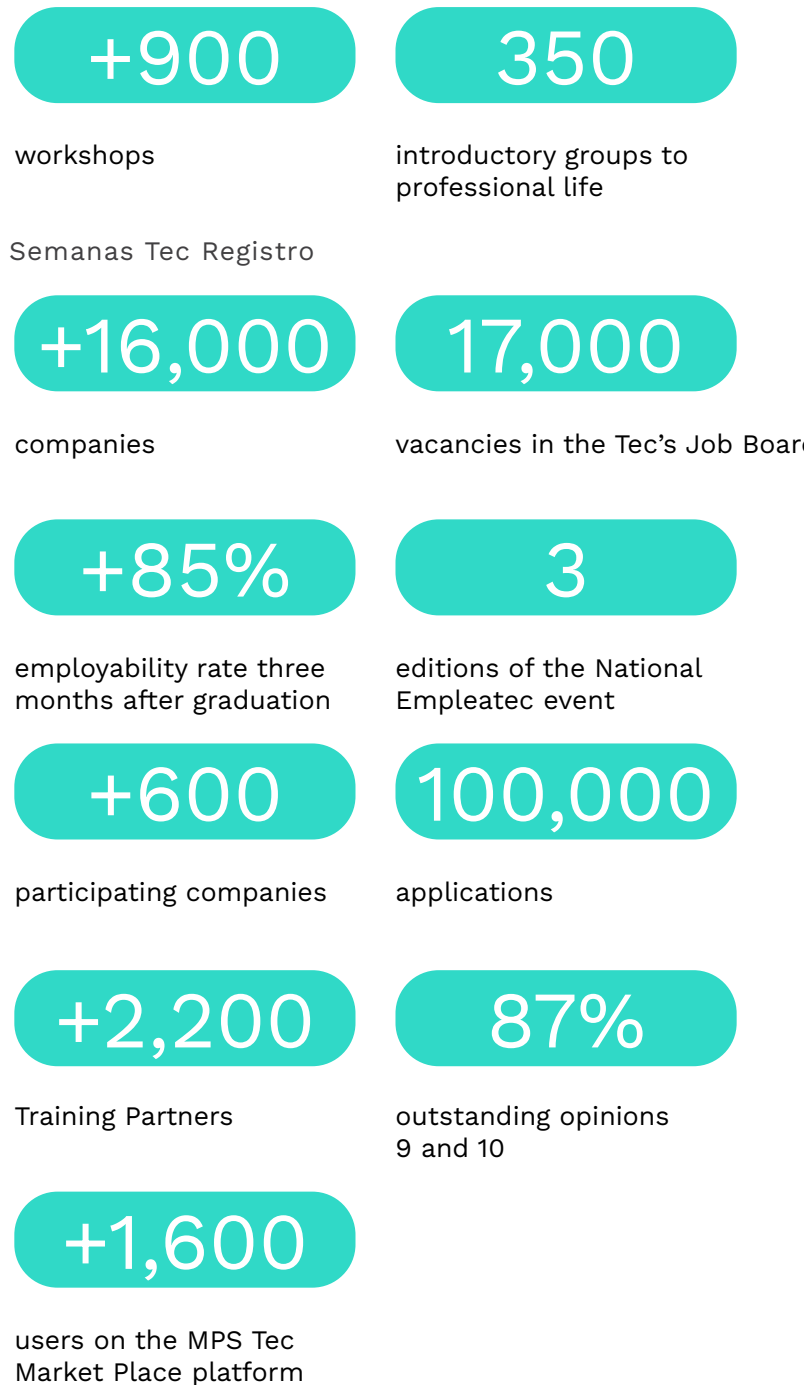

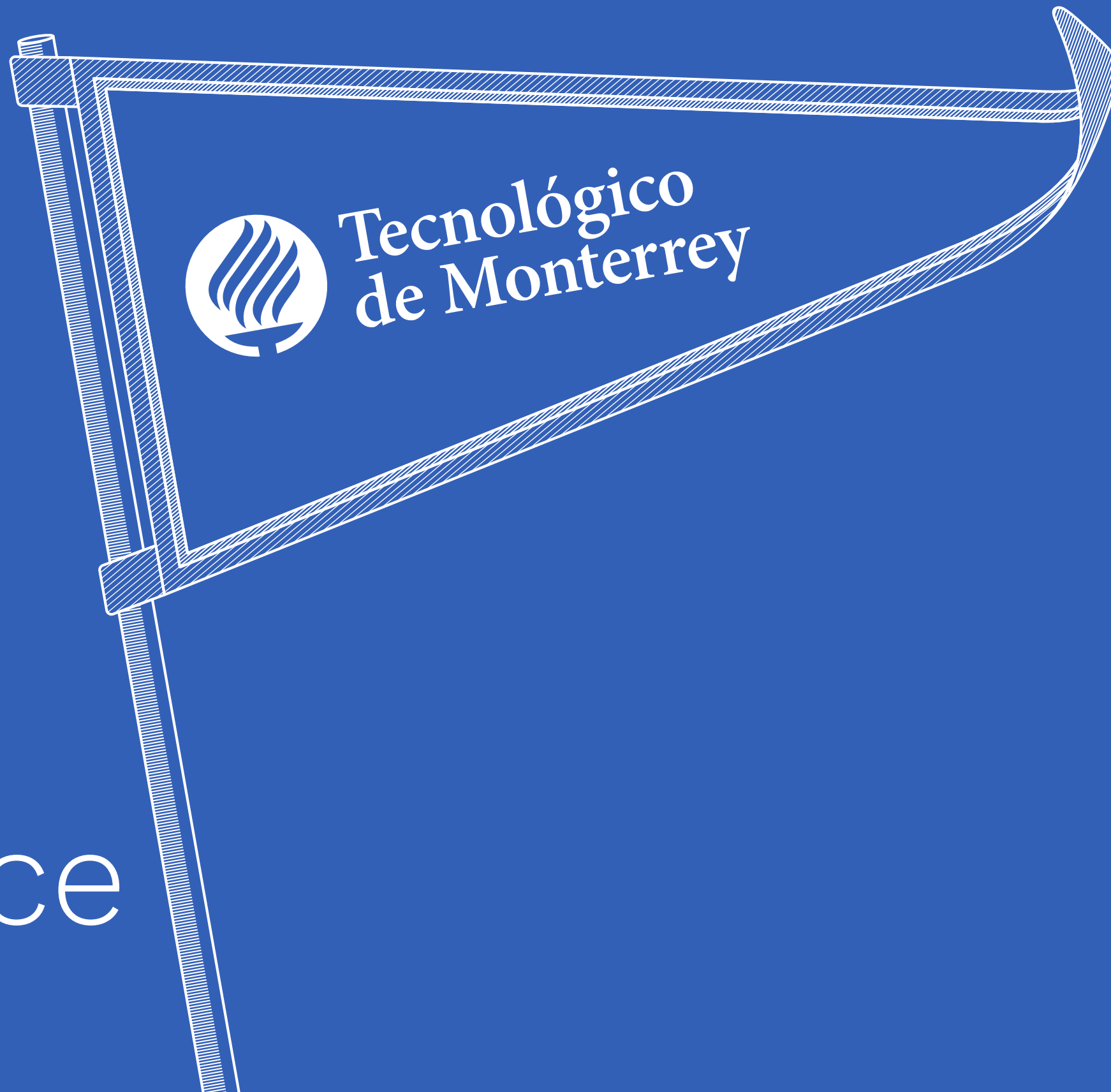

Student  
experience

# Student experience

During 2023, the Tecnológico de Monterrey campuses celebrated significant anniversaries, coloring their facilities blue in commemoration of important milestones. Highlights include the 80 years of the Monterrey Campus, the 50 years of the Ciudad Obregón Campus, 45 years of the León Campus, 40 years of the Sonora Norte, Sinaloa and Ciudad Juárez campuses, the 25 years of the Aguascalientes Campus and the 20 years of the Puebla Campus.

## AN UNFORGETTABLE START TO THE SEMESTER

The August-December semester opened with enthusiasm by welcoming

**+ 12,000**

new students on all campuses. Hi!Tec, organized by current students, provided a warm welcome to newcomers, focusing on key aspects such as the history of Tec, vision 2030, Tec21 Educational Model, campus services and student integration activities.

Furthermore, at PrepaTec coexistence was strengthened through events such as “UNO Day” and “MIL Day”, consolidating identity and the sense of belonging.

### Tec Residences

18 buildings on various campuses that were home to 2,121 students, including 303 foreigners. The inauguration of a new building on the Monterrey Campus will increase the national offer by 15%, which represents going from 2,316 to 2,653 residents.

## TECMED: COMPREHENSIVE CARE AND EXPANSION

The TECMed Center are medical units within our Institution, with the purpose of providing a basic medical care, through 65 operating spaces classified as clinic, office and nursing; provides primary medical care in the 37 facilities located on the different campuses. TECMed Center has 141 health professionals:

**98,335**

medical care services provided in the year

## SELECTIVITY AND SCHOLARSHIPS

With the aim of providing educational support and scholarships to the talent that is part of Tecnológico de Monterrey, in the 2023 August-December semester we benefited:

**40,813**

High School and Undergraduate students

**49%**

of the total population



## UNDERGRADUATE

In 2023, 12,074 students started, whose average grade upon entry was 91.3. The students come from 1,888 different high schools, from 32 countries around the world, as well as from the 32 states and 422 cities or towns in Mexico.

**3.8%**

Growth of PrepaTec in new students

**12,074**

students who entered in August - December 2023.

## GRADUATIONS

This year, 60 graduation ceremonies were held for a total of 17,823 Undergraduate and Graduate students (15,146 undergraduate alumni | 2,374 graduate alumni.)

HISTORICAL NUMBER OF GRADUATE STUDENTS  
**225,950 at all academic levels**  
 (45% growth vs 2022)

### Graduates per school

#### Architecture, Art and Design



#### Social Sciences and Government



#### Humanities and Education

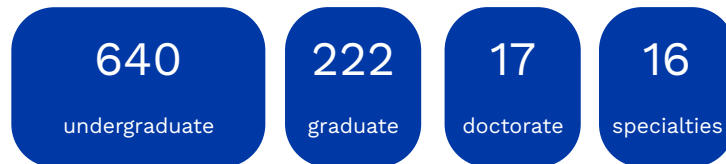

#### Engineering and Sciences

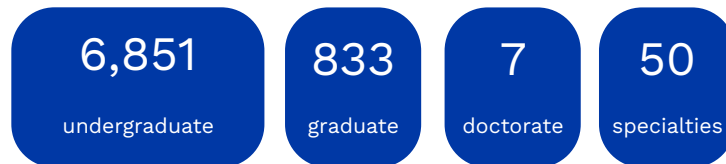

#### Medicine and Health Sciences



#### Business

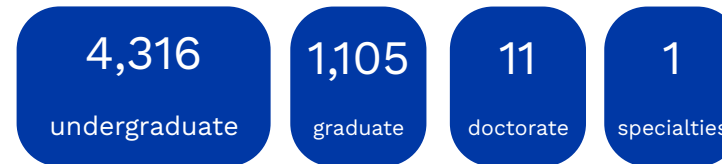

#### PrepaTec

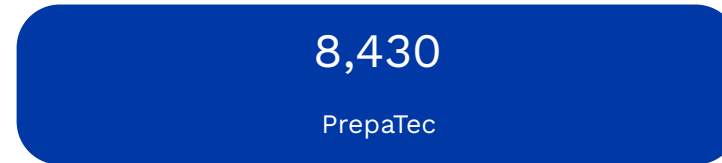

## 2023 EXPERIENCE MANAGEMENT: TRANSFORMATION AND CONTINUOUS IMPROVEMENT

Tecnológico de Monterrey undertook an initiative focused on the design of a new experience management model, obtaining significant improvements in student satisfaction. From registration to graduation, exceptional moments were generated in the student career.

## TecStore

TECstore has been present in more than 500 events nationwide, consolidating itself as a key player in various activities of the Tecnológico de Monterrey.

This year collaborated with EXATEC in the Blue Open Golf Tournament Circuit and partnerships with recognized brands such as Peanuts and Lululemon. The inclusion of products from commercial partners and the entry into new categories show a diversification strategy in TECstore's offering.



## Connection, Learning and Creation Platforms

Platforms such as SoyTutor, Launching Pad, Science Connexion, MPSTec and Tooltec consolidate a solid data analysis strategy to create new value models. With more than 9,600 users, SoyTutor offers student-to-student tutoring, while Launching Pad strengthens professional connections for 8,900 students. More than 1,660 researchers and entrepreneurs are part of science connection, which seeks to promote scientific-technological-based entrepreneurship through the dissemination of talent and calls.



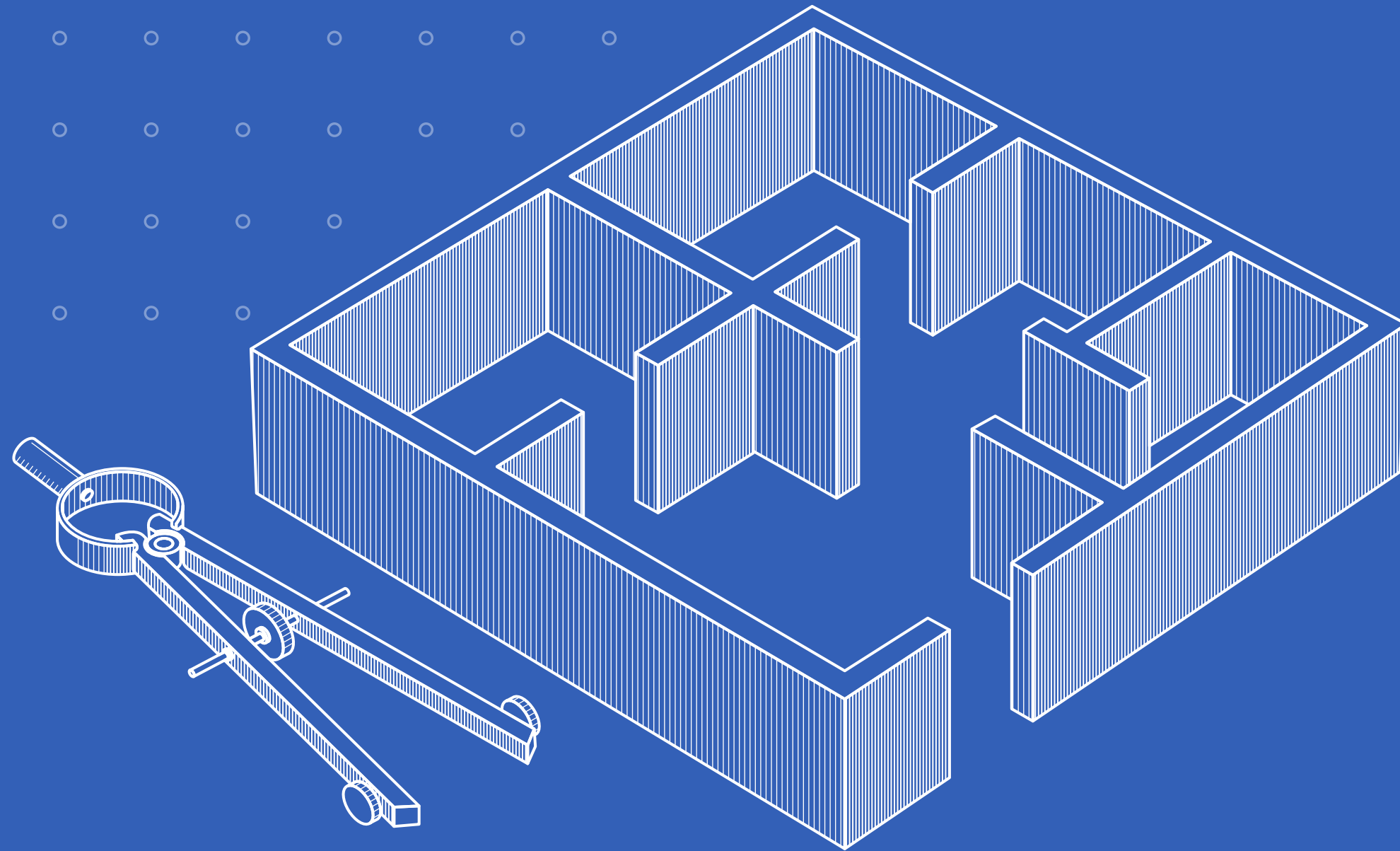

Infrastructure

# Infrastructure

During 2023, Tecnológico de Monterrey strengthened its commitment to academic excellence and innovation through significant improvements to its infrastructure.

projects completed

20,236 m<sup>2</sup>

renovated

10,013 m<sup>2</sup>

built

9,045 m<sup>2</sup>

structurally reinforced to guarantee the safety of the community

+ 30,000 m<sup>2</sup> built and in the process of construction

in Tec, Tecmilenio and TecSalud projects.

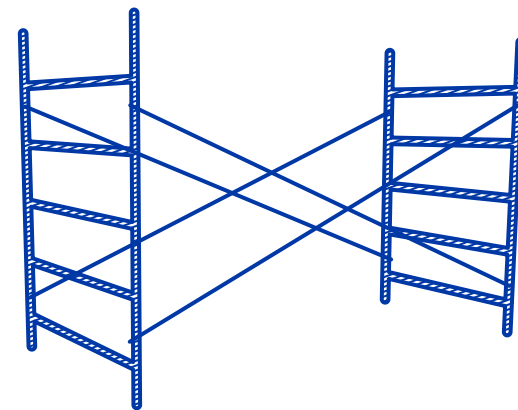

## PROJECTS IN 2023:

### Monterrey

IFE Central Offices 2nd Floor: Remodeling of 390 m<sup>2</sup>, adapting spaces for collaborators and researchers, improving efficiency and the work environment.

Student Associations Phase 2: Focused on improving the logistics, communication and production of student projects, generating an environment conducive to creativity and collaboration.



Residences Phase 1 (Buildings A, B, C): Construction of a new building to house students, promoting mobility between campuses and enriching the student experience.

Cites (Simulation Center): Temporary expansion of the Clinical Simulation Center, improving academic services and ensuring compliance with practices and accreditation requirements.

CAAD (Cites): Adaptation of 80 m<sup>2</sup> for a temporary CAAD project, equipping the space with dental units and specialized equipment.

Facades of the Zambrano Hospital: Replacement of the ventilated façade of the Zambrano Hospital, ensuring structural elements and preserving the integrity of the building.

### Guadalajara

Academic Habitat (CEI Remodeling): Transformation of the Innovation and Entrepreneurship Center to offer high-quality academic spaces.



### Puebla

Classroom Building IV's Structural Remediation: Reinforcement of classrooms ensuring compliance with current regulations and providing a safe environment for learning.

### Mexico City

Inspiring Teacher Statue: Bronze sculptures representing real professors were erected on six campuses. These statues are a work of art that hold an inspiring message from Eugenio Garza Sada, mixing tradition with technology.



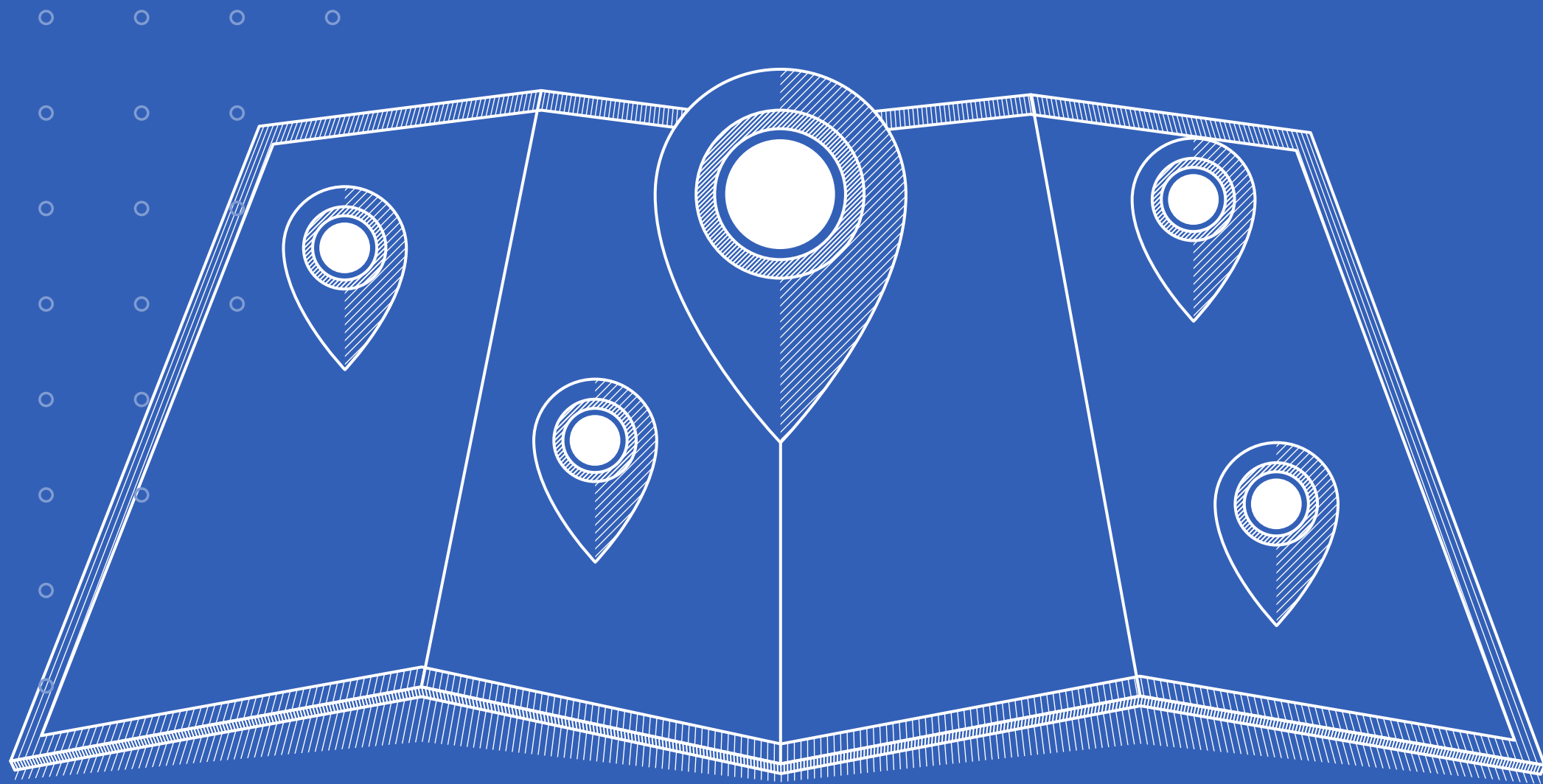

Our Campuses



# Our Campuses

In addition to the successes and projects mentioned in specific sections of this report, such as Entrepreneurship, Infrastructure, LiFE, Schools, PrepaTec and Faculty, in this section we focus in highlighting the progress and initiatives of our campuses, organized by region. In these places, you experience Tecnológico of Monterrey's distinctive culture, which is linked to its communities in academic, training and experience aspects.



## CENTRAL SOUTHERN REGION

The Central Southern region exceeded the donation goal, experiencing a growth of +32%, reaching \$62 millions of pesos through philanthropic initiatives on campuses.

### Cuernavaca Campus

-  Luciano Reyes, a PrepaTec student, was one of the 100 RISE Lifetime Scholarship winners and attended a summit at the University of Oxford.
-  Students achieved first place nationally in the Leadership for transformation block, presenting innovative proposals for the company "Celulosa Arauco".

### Hidalgo Campus



-  Luisa Fernanda López Rodríguez, Miguel Ángel Arenas Hernández and Fredy Mercado Rodríguez, 5th semester students of the LCPF degree, won first place nationally in the video contest of the AMIB 2023 Stock Market Convention.
-  Professor Antonio Cedillo Hernández of the EIC received the certificate for the best presentation at an international conference in Barcelona, Spain.

### Puebla Campus

-  The international event "FIRST Robotics Competition" was successfully held, with the participation of more than 300 high school students and 3,000 attendees.
-  The STEAM Laboratory was inaugurated at PrepaTec Puebla Campus. Students of this Campus were crowned national champions in the event 2023 Enactus México, representing the Tecnológico de Monterrey at Enactus World Cup 2023 in the Netherlands with the eco-friendly project Celal-Mex.



### Querétaro Campus

-  Achieved double-digit growth in new undergraduate students, surpassing the established goal.
-  Querétaro Residences reached 92% occupancy, quadrupling the number of residents from August 2022.

### Tampico Campus

-  It hosted LIDERA RCS for the first time, a regional event in Leadership and Student Education for young people from PrepaTec, receiving 93 students from 10 campuses.





## MEXICO CITY REGION

### Chiapas Campus

- At Chiapas and Mexico City PrepaTec, we received the “Great Place to Study” award, highlighting the happiness, wellbeing and satisfaction of our educational community.

### Mexico City Campus

- Juan Ramón Lara, Biomedical engineering student, led the “Deciding a future” project, recognized with the prestigious “U21 Leaders of the Future” award, highlighting student excellence and innovation. BiblioTec, pride of the CCM campus, obtained the coveted LEED Platinum certification from the US Green Building Council, reaffirming its commitment to sustainability and cutting-edge design.



- The Mexico City Campus Theater company, in collaboration with the Musical Ensemble, won first place in the International University Theater Festival with the play “La última y nos fuímonos”, highlighting Tec’s artistic talent.

### Estado de México Campus

- Quantum Robotics, representing Tec CEM, achieved an outstanding place in the world top 10 of the University Rover Challenge (URC), consolidating itself as a leader in the annual robot competition for space exploration.
- Liliana González, student of International Relations, won the University Debate World Championship in Spanish.

### Santa Fe Campus

- The CSF Flag Football Borregas achieved a memorable victory at the NRG Stadium in Texas, celebrating Tec’s 80th anniversary.



- Three students from this campus participated in the Pan American Games in the climbing and sailing categories.

### Toluca Campus

- The Toluca Campus won the silver medal in the “Big 8” university basketball championship.
- The selection of two students for the 2023 Central American Games and outstanding recognition in the 2023 FIRST Robotics Competition.

## MONTERREY REGION

### Monterrey Campus

- The Innovation District of Monterrey Campus, part of distritotec, was invited to the World Economic Forum to share advances in research, innovation and entrepreneurship.
- During the “Urban Transformation Summit 2023” held in Detroit, United States, Tec’s experience in the development of the Innovation District was presented. Focusing on the communication of science and technology through art and innovation, it participated in the “Global Partnerships” forum.
- 15 neighborhoods and around 20 thousand people benefited from the implementation of the Campana-Altamira Initiative in its “In this band we all play” phase, seeking to improve mobility, accessibility and social and environmental regeneration in the area.
- In the August-December semester, the Monterrey distritotec actively participated in 29 groups, managing more than 130 projects.

- 

The VantTec student group developed the autonomous vehicle “Self Driving Vehicle (SDV)”, exhibited during Tec’s 80th anniversary, standing out for its control through a video game and its contribution to the field of autonomous mobility.



- 

The short film PÁLIDA, made by students from the film production and direction concentration, was a finalist at the Cannes short film festival, winning awards at several international festivals.

- 

Eight athletes from Borregos Monterrey represented Mexico in the 2023 Pan American Games in Santiago, Chile, standing out in basketball, swimming and taekwondo.

- 

The Department of Art and Culture presented more than 20 shows in 2023, participating in the 2023 Santa Lucía Festival with the show Dracula, highlighting the cultural impact of Tec in the community.

- 

**Center for the Future of Cities**  
It is a center of thought and action based at Monterrey Campus, focused on the planning and transformation of cities as sustainable, humane and prosperous environments. In 2023, the CFC has consolidated a series of key achievements that have reinforced its commitment to applied research, innovation and positive impact on the urban environment.

- 

The Botbusters 4635 team from PrepaTec Eugenio Garza Sada won the silver medal in Engineering Innovation at the 2023 First Global Challenge in Singapore.

### Salttilo Campus

- 

The robotics teams from the Tec de Monterrey Saltillo Campus were awarded at the 2023 VEX Robotics World Championship in Dallas, Texas, standing out for their skills and contributions at this prestigious international event.

- 

We won the categories: Innovate Award, Create Award and Energy Award, recognizing their skills and contributions at this prestigious international event.



## NORTH REGION

### Chihuahua Campus

- 

21 International Business students from this campus participated in the 2023 SIAL fair in Toronto, promoting products from 5 Chihuahua companies, under the coordination of Silvia Medina, Director of the LIN program and the support of 8 mentor professors.

- 

Clinic operations began in collaboration with the IOM-UN Migration, providing advice on immigration procedures and other services, reflecting the Tec’s commitment to the needs of migrants.

- 

The Reforestation of the Sierra Tarahumara project was carried out using drones, led by students of Mechanical Engineering, Sustainable Development and Biotechnology from the Chihuahua, Querétaro and Mexico City campuses in collaboration with the La Norteña Group, with a focus on fire damaged areas.

### Laguna Campus

- 

Launch of the Multicultural program at PrepaTec Laguna Campus, to educate global citizens.

- 

The School of Creative Studies at the Laguna Campus carried out a series of training experiences in the Magical Town of Parras de la Fuente, highlighting the practical approach and connection with the community.





- 

With the participation of more than 1,300 people, the Tecnológico de Monterrey Laguna Campus was the home of the Artificial Intelligence and Metaverse Symposium, an event organized with Grupo Milenio. The forum had 12 national speakers, seven of them professors and researchers from our Institution, 6 workshops and different stands from companies such as Qualcomm, Getty Images, Peñoles and AstraZeneca.

### León Campus

- 

The León Campus promoted innovation with initiatives such as MIT REAP with 9 events held, with more than 600 impacted participants, 20 science and technology projects in incubation programs, Tec acceleration, 2023 Startup Congress, and programs such as Tec Beyond. All of these show the Campus' commitment to innovation and entrepreneurship.
- 

The Borrego Sculpture was installed, and reforestation programs were carried out within the framework of the 80th anniversary, demonstrating the Tec's focus on comprehensive education and care for the environment.
- 

Important infrastructure works were carried out including the relocation of the TecMed and improvements to the Main Cafeteria and the inauguration of an OXXO, reinforcing the Tec's commitment to an optimal learning environment.

### San Luis Potosí Campus

- 

The LamBot 3478 robotics team from PrepaTec San Luis Potosí reached the semifinals in the FIRST Championship.

- 

Successful collaboration with Bosch Talento México in 13 interdisciplinary projects, where 60 students and professors from the School of Business and Engineering and Sciences of the San Luis Potosí Campus participated.

- 

Host campus of the 2023 MONULAC conference.

### Sonora Norte Campus

- 

The foundation stone of the HIP was laid, an innovative building with significant investment to advance in technology and practical training in engineering and architecture.
- 

Students Carlos Erquizio and Fernando de Silva, from PrepaTec Sonora Norte, won the Stockholm Junior Water Prize 2023.
- 

PrepaTec Sonora Norte Campus professors Ludovic Betton and David Vizcaino obtained first national place in the 2023 TecduHack Educational Innovation Hackathon.

## WESTERN REGION

### Aguascalientes Campus

- 

Successful representation of students from the School of Engineering and Sciences in the Shell Eco-Marathon Americas competition, breaking records and demonstrating talent and dedication. diferentes y destacando las habilidades de liderazgo de los students.

- 

Success of the 2023 Intercampus Borrego event, bringing together more than 1,200 participants from 11 different campuses and highlighting the leadership skills of the students.



### Ciudad obregón Campus

- 

Student Ana Paula Casas from PrepaTec Ciudad Obregón stars in an NBA short film and wins first place in the NBA Films for Fans Mexico contest.
- 

The 50th anniversary of the campus is celebrated.

### Colima Campus

- 

The HORUS robotics team obtains the WINNERS AWARD at the FIRST Robotic Competition and participates in the Robotics World Cup in Houston with 40 students, highlighting the autonomous capacity of the robot.

## Guadalajara Campus

- 

Campus Guadalajara, in collaboration with Wizeline, has marked a milestone in the Artificial Intelligence field with the creation of GAIL, the first Generative Artificial Intelligence laboratory in Mexico and Latin America.
- 

A scholarship program was established for students over the next 5 years, providing access to new technologies and academic programs related to AI.
- 

The students of the Mechatronics degree obtained 2nd and 3rd place in the sumobot category at the RoboRave World Championship competition, held in China.



## Morelia Campus

- 

The First TecBeyond Generation in Morelia 2023 brings together entrepreneurs and government officials in a leadership and innovation program for Senior Management. Through classes, conferences and workshops, collaboration and innovation in the business ecosystem are encouraged.

## Sinaloa Campus

- 

Opening and remodeling of various spaces, including laboratories and cafeteria, to benefit the entire student community.
- 

PrepaTec Sinaloa's Sinavolt robotics team manages to be team captains and receive two "Rookie" awards in their first participation in the FIRST regional robotics competition, in China.
- 

The campus' 40th anniversary was celebrated, commemorating decades of entrepreneurial leadership and contribution to education in the region.

## Zacatecas Campus

- 

Opening of the Art Gallery, highlighting the transformative impact of art on society through exhibitions and active participation. With 6 exhibitions that have given voice to 12 talented artists and attracted more than 300 people, this gallery has forged a vital space for the promotion of visual art, elevating the work of Zacatecan artists and projecting it to the world.





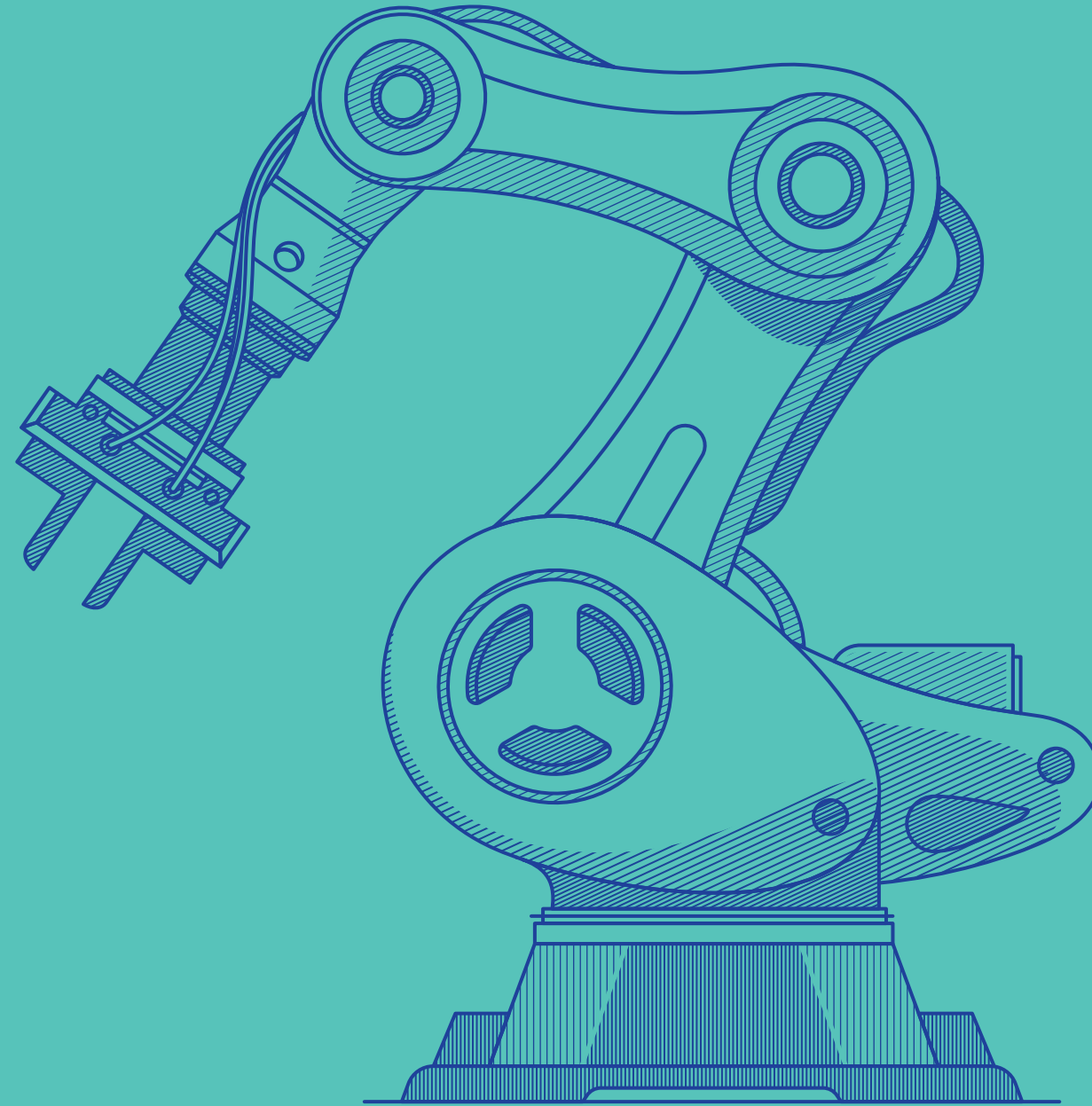
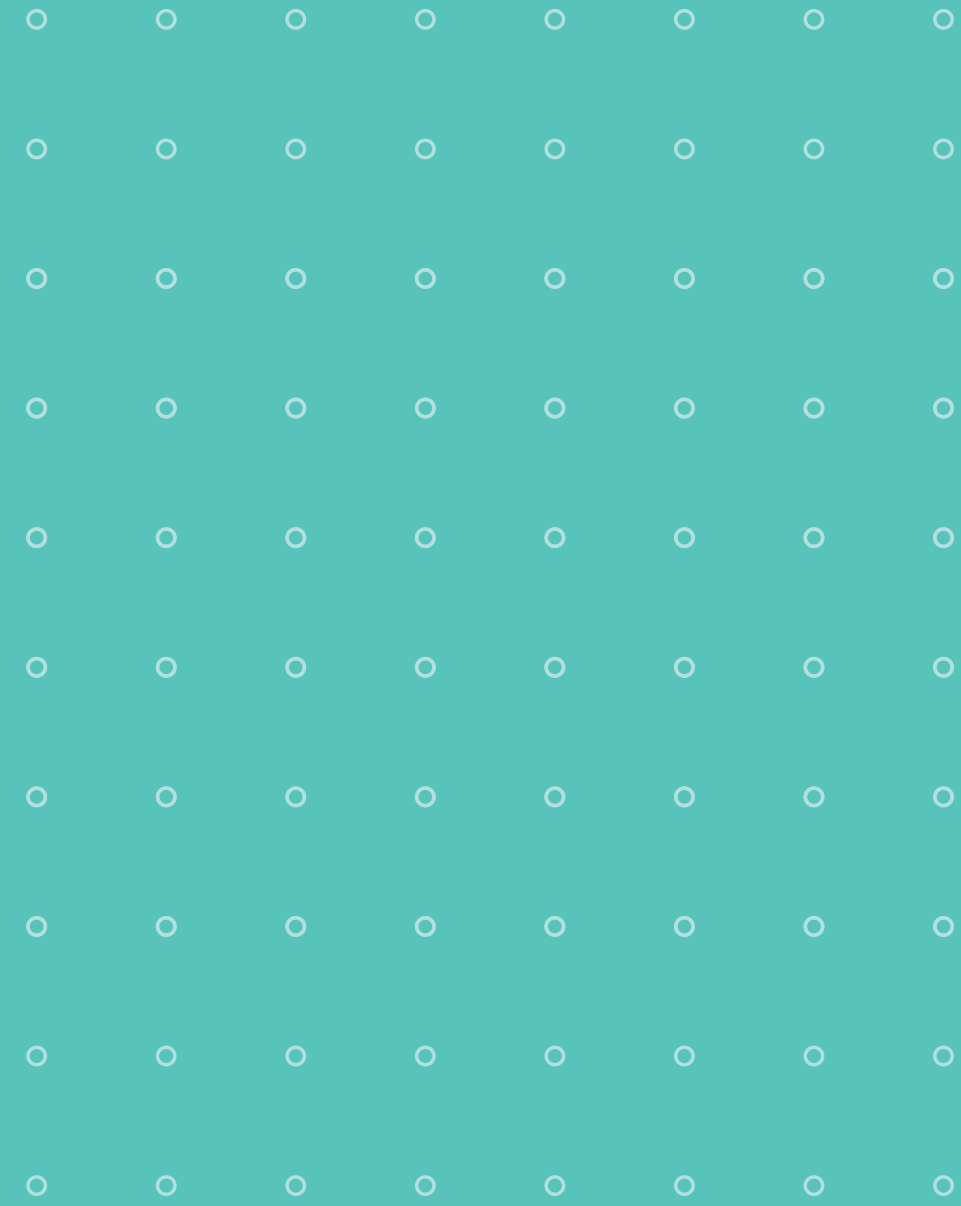

Research

# Research

Tec de Monterrey puts science into action to promote Human Flourishing. Our purpose is to create knowledge based on interdisciplinary research that generates viable solutions to overcome the most important and critical problems of humanity.

Through research, innovation and entrepreneurship, Tec seeks to contribute to solving problems that affect society.





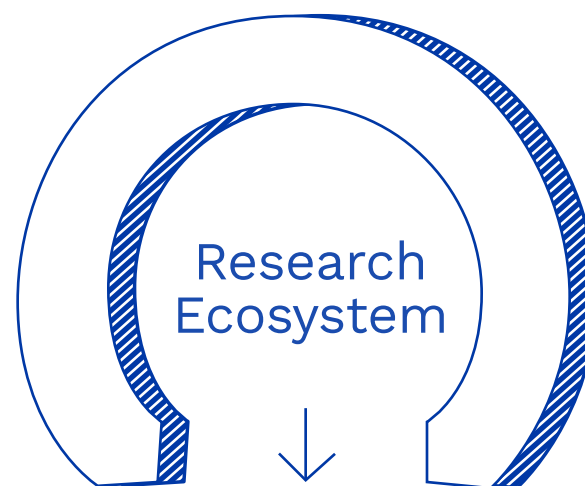

-  **Institute of Advanced Materials for Sustainable Manufacturing**
-  **Institute for the Future of Education**
-  **Institute for Obesity Research**
-  **oriGen**
-  **Centro de Primera Infancia**



Science based Entrepreneurship

-  Data Science
-  Genomics
-  Additive Manufacturing
-  Pre-Clinical Research Unit

## INTERDISCIPLINARY RESEARCH INSTITUTES

Interdisciplinary research institutes are the vehicle to execute our research in critical fields mission.

### Institute for the Future of Education

The Institute for the Future of Education aims to create, disseminate and apply knowledge on research-based educational innovation. Through its initiatives, it seeks to improve the lives of millions of people by transforming higher education and promoting lifelong learning.

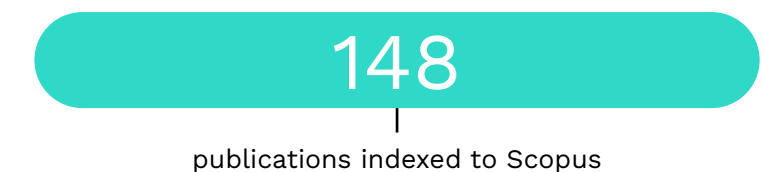

The Institute offers initiatives for universities, governments and companies in the following areas:

- Interdisciplinary research
- Entrepreneurship and technology transfer
- Impact and consulting projects
- Dissemination and community creation

Scope by initiatives in 2023:

130

high-quality proposals received in the fourth edition of the TecPrize call

**Innovation Hub Europe**

The Innovation Hub Europe was inaugurated in Spain to promote collaboration between the IFE and European universities. As part of the inauguration, a bootcamp on the future of education was held. The Hub will allow participation in proposals for European funds.



**Living Lab & Data Hub**

The Living Lab began experimentation in the Experiential Classroom in collaboration with the Massachusetts Institute of Technology (MIT), the Hague University of Applied Sciences, the University of Groningen and the University of Tokyo. Likewise, it launched the Living Lab EdTech Marketplace within the Edutec conference in Panama, with the participation of 30 EdTechs from Latin America.

The Data Hub provided data to more than 100 researchers from 14 countries, 26% coming from other national and international institutions. The available data collections account for more than 25 years of student and professor history across more than 700 variables.

**IFE Observatory**

The weekly newsletter in Spanish by the IFE Observatory was named on February 23, 2023, as: “The main Latin American newsletter in education”, by the Spanish educational magazine Espacios de Educación Superior.

**CIIE 2023**

On January 16, 17 and 18, 2023 in the city of Monterrey, the IX International Congress of Educational Innovation, CIIE 2023, “The future of education”, was held with:

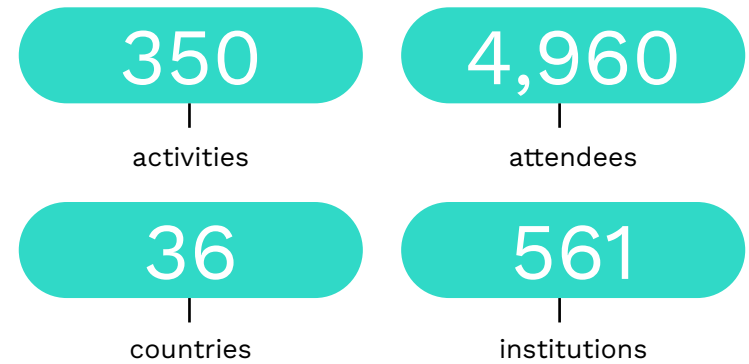

**Institute for Obesity Research**

Within the framework of the first anniversary of the launch of the Institute for the Obesity Research, the 2nd International Congress on Obesity was held, with more than 2,800 registrations. In 2023, the strengthening of the research group stood out thanks to the incorporation of two more researchers to the Faculty of Excellence: Richard Willson from UH, and Per Olof Berggren from the Karolinska Institute.

In addition, two inter-institutional collaborations were generated related to the joint funding of research projects through “Matching Funds”, with Arizona State University and the University of the Andes. At the same time, a relationship was initiated with the RamBam HealthCare Campus in Israel for a third inter-institutional collaboration.



**Institute of Advanced Materials for Sustainable Manufacturing**

During 2023, the Institute contributed to combating climate change through the development of advanced materials and sustainable manufacturing processes, focusing its innovation, research and technological development activities on the following topics: additive manufacturing, smart materials, sustainable plastics, waste revaluation, CO2 capture and products, digital technologies for the development of advanced materials and sustainable manufacturing.



Also noteworthy is the strengthening of the group of researchers, through the attraction of Dr. J. Gabriel Luna Bárcenas, Faculty of Excellence, dedicated to the development of smart materials.



Furthermore, during this period, three projects with the Southwest Research Institute were jointly approved and four projects with the University of Alberta with the purpose of boosting technological developments linked with specific industry interests. We started the joint project with Baker Institute for Public Policy from Rice University, Nearshoring Opportunities and the Challenges, aimed at identifying innovation needs of the industry in Mexico and the United States.

This year, the 2nd International Congress of the Institute on Advanced Materials and Additive Manufacturing was held, an event with representatives from Frisa Aerospace, GE Additive, GE Aerospace, Nemak, Siemens, Automotive Cluster of Nuevo León, Aerocluster Nuevo León, Institute of Innovation and Technology Transfer of Nuevo León, University of the Basque Country, University of Alberta, National Laboratory for Additive and Digital Manufacturing of the UNAM and the Southwest Research Institute.

199

publications indexed to Scopus

**oriGen**

The **oriGen** project aims to contribute to solving major health problems through research and innovation developed from genomic (proteomics, metabolomics) and clinical/epidemiological information from 100,000 Mexicans.

In 2023, we achieved the participation of +33,000 people and the stage in Nuevo León was concluded. In addition, a collaboration agreement was signed with Regeneron Genetics Center. With this agreement, we open the possibility of reviewing the exomes of all the project samples and, in addition, the complete genome sequencing in the samples of 10,000 individuals. This will allow the analysis of genetic characteristics with all the information collected.

Tecnológico de Monterrey and Microsoft signed a collaboration agreement which allows access to solutions and services from the AI for Good program, as well as cloud, artificial intelligence and data analysis capabilities to provide support to scientific research projects such as the oriGen project.



**Early Childhood Center**

This year the Early Childhood Center was launched, in collaboration with the FEMSA Foundation. Its purpose is to promote the wellbeing of early childhood through transdisciplinary and applied research, dissemination and transfer of information, articulation and training of key actors in the ecosystem to contribute to the creation and strengthening of public policies, programs and innovative, scalable solutions, with regional scope and evidence-based.



**CORE LABS**

Core Labs are world-class research facilities where researchers have access to state-of-the-art specialized spaces. The Core Labs of Genomics, Data Science and the Preclinical Research unit are the go-to place for companies and industry leaders looking to conduct research.

This year the Additive Manufacturing Core Lab was inaugurated, within the framework of the Second International Congress on Advanced Materials and Additive Manufacturing. This Core Lab will be focused on the design and manufacturing of materials for industry, as well as providing care and specialized services for researchers from both the Institute and companies and other institutions.





## RESEARCH IN THE SCHOOLS

The National Schools play a fundamental role in materialize the research vision of Tecnológico de Monterrey. Their contribution goes beyond disciplinary research, encompassing the growth of existing institutes, attracting funding, and promoting a research culture in high-performing communities.

The National Schools are pillars for the connection between research and scientific graduate studies, establishing the relationship with the Tec21 Model. In addition, they serve as drivers of the development of research professors, intellectual vitality, and disciplinary updating of the faculty.

In 2023, there was a total of:

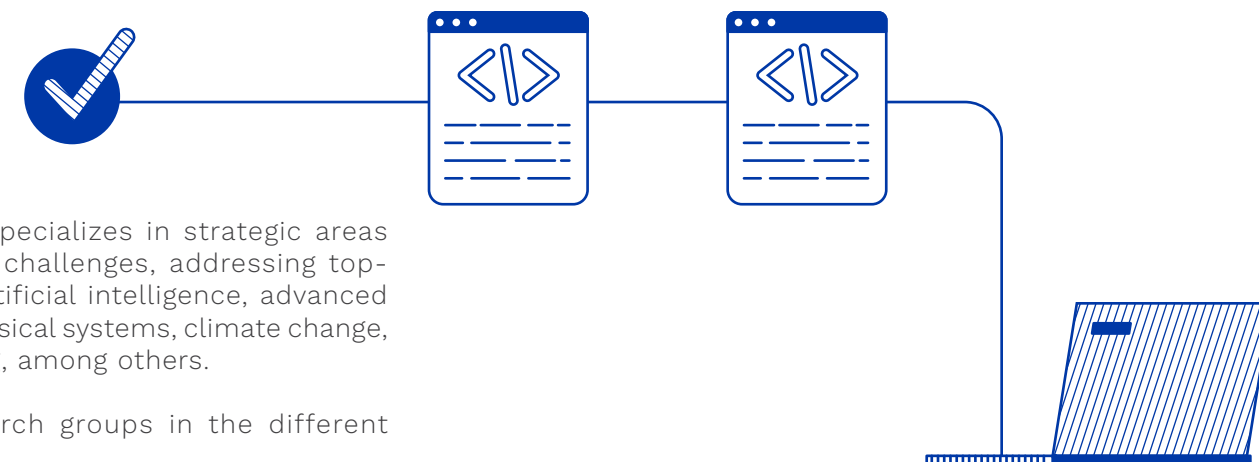
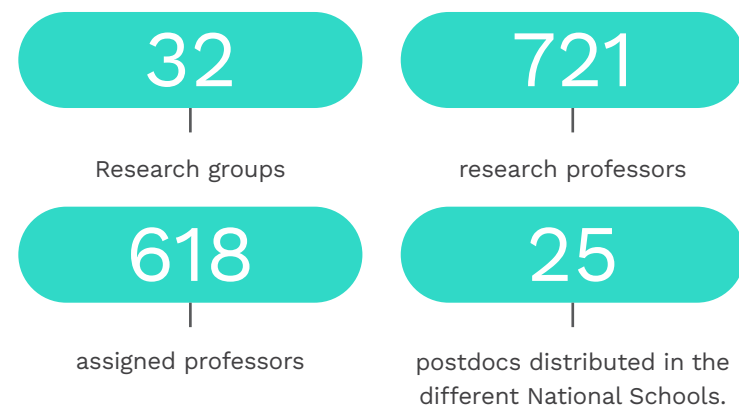

This research network specializes in strategic areas that face contemporary challenges, addressing topics such as advanced artificial intelligence, advanced manufacturing, cyber-physical systems, climate change, molecular bioengineering, among others.

These are the 32 research groups in the different National Schools:

### School of Engineering and Sciences

- Advanced Artificial Intelligence
- Advanced Manufacturing
- Cyber Physical Systems
- Decarbonization, Climate Change and Circular Economy
- Emerging Food Technologies and Nutraceuticals
- Energy Conversion, Storage and Management
- Innovation in Smart Digital Technologies and Infrastructure
- Molecular and Systems Bioengineering
- Nanosensors and Devices
- Photonics and Quantum Systems
- Smart Supply Chain and Logistics
- Water Science and Technology

### School of Medicine and Health Sciences

- Developmental Biology and Comprehensive Well-being in Childhood
- Global Health and Emerging Diseases
- Diagnostic and Therapeutic Innovation in Chronic Degeneration Diseases
- Neurological Sciences and Neurorestoration
- Research in Breast Cancer
- Advanced Therapies in Visual Sciences

### School of Business

- Impactful Entrepreneurship and Innovation
- Organizational Strategy and Industries Transformation
- Development of Conscious Businesses
- Leadership and Effective Organizations

### School of Architecture, Art and Design

- Sustainable Territorial Development
- Advanced Design Processes for Sustainable Transformation
- Critical Theory of Art and Design

### School of Sciences and Government

- Legal Systems Innovation
- Democracy and Global Affairs
- Economies of the Future
- Government and Public Entrepreneurship

### School of Humanities and Education

- Humanities for Sustainable Development
- Digital Humanities
- Educational Innovation

## SCIENTIFIC AND TECHNOLOGICALLY-BASED ENTREPRENEURSHIP

Our objective is to apply knowledge to generate solutions, through the creation of specialized companies, which give place to the main academic researchers, through an ecosystem of entrepreneurs, scientists, engineers and experienced partners.

In 2023, we launched Science Connexion, a platform that promotes science and technologically-based entrepreneurship and provides resources for innovators interested in commercializing an invention, starting a company or collaborating with industry partners.

In this first phase, the platform allows the launch of calls that seek to support the solution of complex challenges that society faces today, where science and technology are the most relevant factor in solving them.

### In addition, the development of four spin-offs stands out:

- Smart-Tec Bio-Health: consists of a digestive tract simulator for the analysis of ingredients in the human and animal microbiota of foods and medicines.
- Horizon Architecture: A general-purpose framework and Data + AI system to address complex tasks within fractal dimensions in networks.
- Ocular Biodesign: focuses on the development of collagen membranes for ophthalmological use, for the treatment of corneal opacities due to intracorneal transplantation.
- Sytosol: focuses on the development of sensors for health sciences and biotechnology, with nano-devices, ophthalmological and cancerological applications.

## COLLABORATIVE RESEARCH

Tecnológico de Monterrey has established international collaborations with universities and institutes ranked among the best in the world, such as: Southwest Research Institute (SWRI), Massachusetts Institute of Technology (MIT), University of Alberta, Arizona State University (ASU), University of Texas at San Antonio



(UTSA), University of Ottawa, University of California, Universidad de los Andes, among others. These alliances foster active participation and collaboration that has led to the creation of seed funds to promote research and development projects.

The Consortium for Research, Technology Transfer and Entrepreneurship UNAM-TEC seeks to promote plans with a global vision and impact that promote progress, advancement and use of scientific knowledge, where research groups called Binomios UNAM-TEC collaborate. This year, eight calls were made both internally and with industry allies such as Imbera, Cemex, BBVA, KOF and Siemens and more than 15 projects are being supported.

We also highlight the opening of the first call of the UANL-TEC Consortium, where seven projects were approved that seek to provide solutions in health, education, industry 4.0 and sustainability.

As part of the Alianza Empeñe Salud, comprise of FUNSALUD and Tecnológico de Monterrey, the first call for Cardiometabolic Diseases was held. The GSE Biomedical startups were selected, with the proposal to reduce the time of antiplatelet treatment in patients with cardiometabolic diseases, with the use of bio-absorbable medical “stents”; and the startup Essenx Medicina de Precisión, a Mexican company that develops products with technology to identify risk factors and genomic diseases in order to support traditional medical diagnosis.

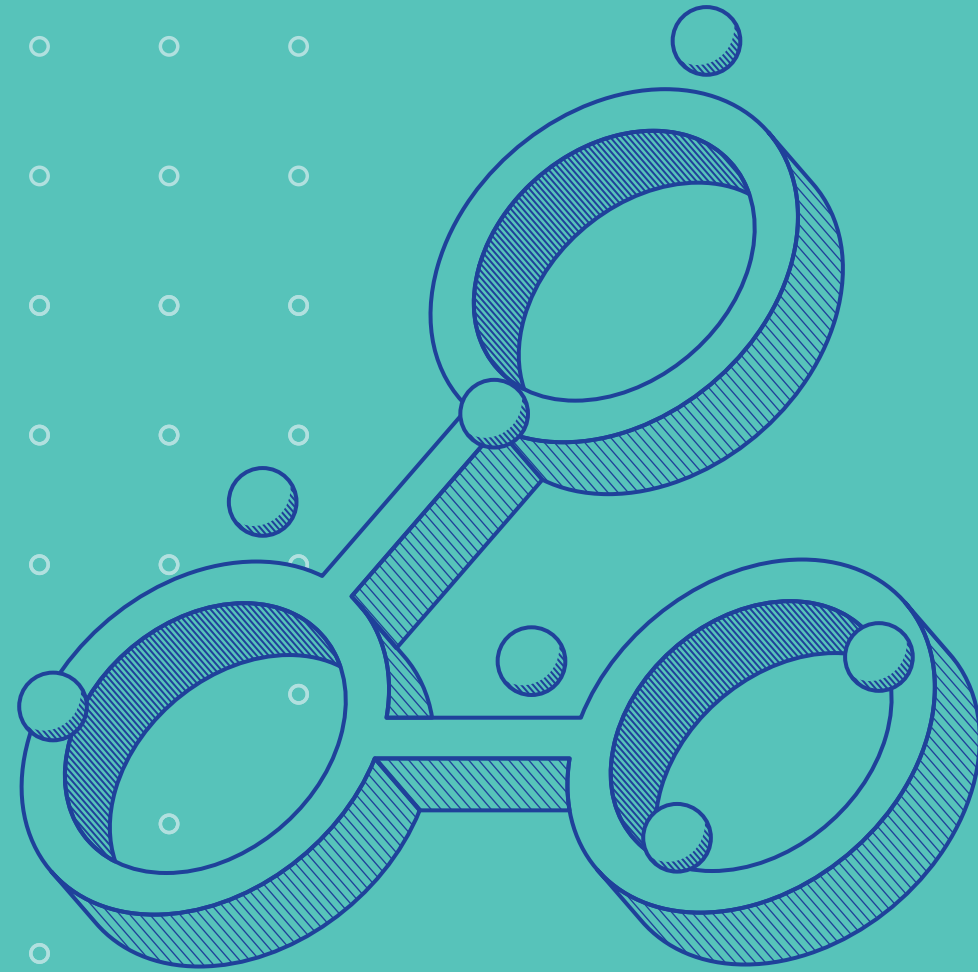

# Partnerships with Organizations and Society

# Actions to guide and transform

## INITIATIVES WITH IMPACT IN SOCIETY

Seeking to transform the communities in which Tec lives, in 2023 the number of social impact initiatives involving students, professors and the Tec community in general increased. In this period the following stand out:

- The Social Service program involved more than 80,000 students.
- The Tec Volunteering program, which increased its projects offer, managed to impact more than 350,000 people through its social initiatives.
- The Leaders of Tomorrow Program expanded its borders and now has students from five Central American countries.
- The digital inclusion initiative aims to implement programs to create better opportunities and living conditions for students, professors, parents and communities, through easy access to technology, training and quality education to the benefits that the digital world provides.

### Prepanet

Prepanet is an online high school that seeks to close the inequality gaps derived from educational lag in Mexico and generate effective inclusion opportunities. In 2023 it had:

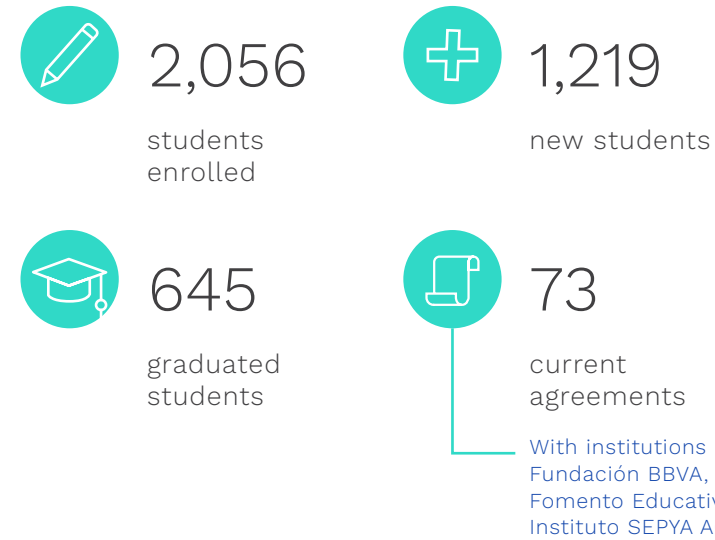

### Institutional Volunteering

Tec volunteering seeks to endorse our commitment to being an institution of society for society, through the generation of initiatives with high social impact that improve the quality of life of more than 350,000 people. These initiatives focus on the areas of education, the fight against hunger and the recovery of natural and public spaces, among others.

#### Sponsor a School

125 schools with improved spaces

35,000 people impacted

+10,500 people benefited from the distritotec Street Market initiative, where small entrepreneurs offer services that have social impact (compost manufacturing, pet care services, etc.)

#### Volunteering for Education

1,362 professors certified in digital skills programs

340,500 high school students impacted with the resources generated by professors





## Hambre Cero

We worked with the Network of Food Banks

100

volunteers

+5,000

students participating in food collection activations

26

participating Tec locations

19

food banks receiving collections

10,880

people impacted through food banks

## Social Service

The Social Service program seeks to develop skills and competencies that allow Undergraduate students to put personal talent and professional excellence at the service of others.

87,277

students completed one of the five social service educational units

6,866,696

hours of social service

875

education partner organizations participated

574,378

people impacted



## Leaders of Tomorrow

Leaders of Tomorrow is a personal transformation, inclusion, and social impact program for the training of transformative leaders. It is focused on young people with outstanding talent who require 100% financial support to study a bachelor degree at the Tecnológico de Monterrey.

The program focuses on attracting students with excellent academic results in Mexico, and from 2022 also in Central America, through the Leaders of Tomorrow LATAM program.

In 2023 there were five students from Panama, the Dominican Republic, Guatemala, Honduras and El Salvador.

Thanks to the leadership and generosity of the program's donors, 10 years after its creation they have managed to achieve:

+360

scholarships with the intention of perpetuity

The program began with the support of 20 donors, and today we have formed a community of more than 10,000 people. In the last year, donations of more than 198 million pesos were obtained.

At Tec, the donor community is celebrated and recognized through the Leaders of Tomorrow Donor Thank You Mural, which represents unity, collaboration and solidarity. The first gratitude mural was inaugurated on Monterrey Campus in 2020. Today there are three other recognition spaces located on Chihuahua, León and Querétaro Campuses.



With the Leader to Leader Scholarship initiative, which is created by the Leaders of Tomorrow students themselves, 10 students were able to benefit.

In December 2023, as part of the celebration of its tenth anniversary, there is a community comprised of:

10 generations

884

students

1,056

graduates

## Digital Inclusion

The Digital Inclusion program focuses on closing the digital gap through access and management of digital technologies that allow the development of technological skills required in daily life and competencies applicable to the work context.

In 2023:

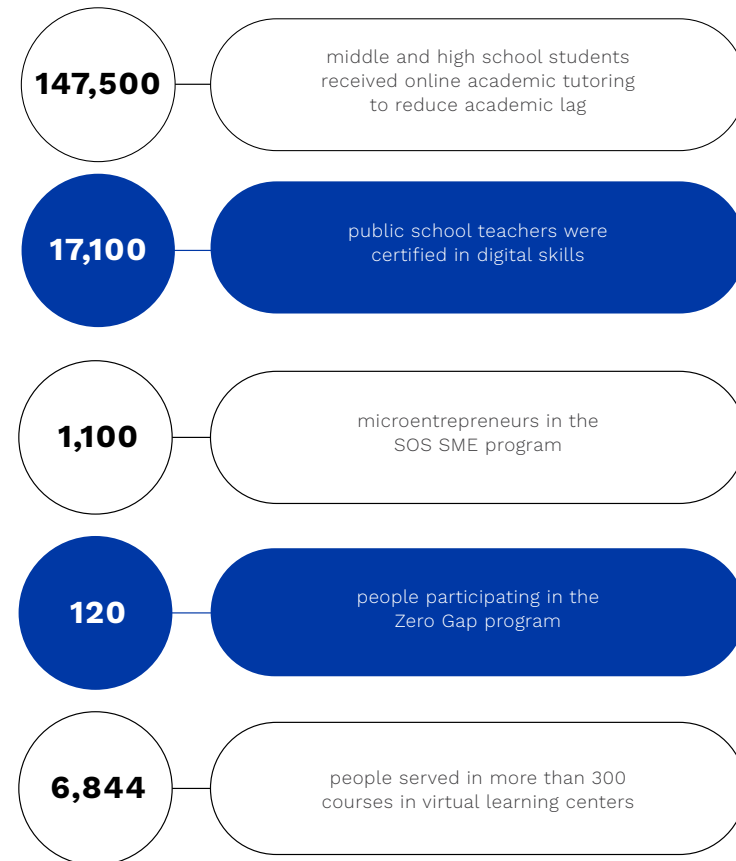

## BUILDING GENEROSITY

### Committed to strengthening a culture of generosity

The purpose that inspires us is to connect and enhance the transcendence of people through a culture of generosity.

Seeking to transform the communities in which Tec lives, in 2023 the number of high social impact initiatives involving students, professors and the Tec community in general increased.

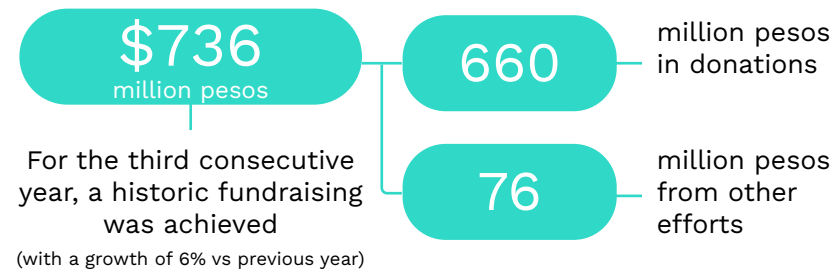

The more than 100 causes of Tecnológico de Monterrey allow us to influence as a platform for transformation. Thanks to a community of:



Which has allowed us to continue creating opportunities to promote academic talent as well as the creation of environments that foster learning experiences.

### Committed to Guerrero

Thanks to the generosity of donors it was possible to support the Guerrero community affected by hurricane Otis:



### Generosity networks



Two new networks were activated: one in Querétaro Campus, which led to the creation of a scholarship with the intention of perpetuity, and another in Ciudad Obregón Campus, which will provide academic support to the students of that campus.

In 2023, 6 Development Committees were activated on the San Luis Potosí, Sinaloa, Toluca, Cuernavaca, Puebla and Saltillo campuses, to promote the culture of generosity in their respective communities.



## THE LEGACY OF OUR EXATEC AT TEC DE MONTERREY

We are proud to share the extraordinary work of generosity of our Tec de Monterrey alumni. We have made notable progress in the Development area of EXATEC, and on this special occasion, we celebrate that, in the year we celebrated our 80th anniversary, outstanding alumni left a legacy that will transcend our academic community. The great commitment to the wellbeing of

society of three exemplary and visionary leaders has played a fundamental role in the creation of emblematic spaces within the Tecnológico de Monterrey that will contribute to the education of excellence and the human flourishing of our students and professors..

### 1. Eduardo Garza T. Innovation and Entrepreneurship Hub Monterrey Campus

As part of the evolution of distritotec towards an innovation district, the Innovation and Entrepreneurship Hub will be created, which represents an ecosystem where creative minds converge to develop innovative solutions and promote the entrepreneurial culture that has always distinguished Tec de Monterrey and who generously will make this space possible: **Eduardo Garza T. Fernández** and his family. Eduardo, is an EXATEC graduate of Civil Engineering, and is the founder of Grupo Frisa Industrias, a company that he created at the age of 23 and that today, after 50 years of its foundation, is positioned as one of the most important forging companies of the world. Motivated by his values and his drive for entrepreneurship, his legacy will transcend to all entrepreneurs in Mexico, creating connections between them, investors and industry to accompany the transformation of innovation projects into technology-based ventures.



### 2. Carlos Álvarez Design and Engineering Center Monterrey Campus

The Carlos Álvarez Design and Engineering Center is a space that promotes creativity, experimentation and resolution of complex challenges. In addition to fostering multidisciplinary collaboration and interaction between students, professors and training partners, the infrastructure will be designed to inspire and educate the leaders of the future, offering an environment conducive to practical learning, collaborative design and the prototyping of innovative solutions. The Design and Engineering Center is an initiative driven by the generosity and vision of an EXATEC that fills us with pride: **Carlos Álvarez**, Biochemical Engineer, who with his closeness and commitment to the Tecnológico de Monterrey contributes to the future of higher education and demonstrates the importance of training people so that they are capable of addressing current and future challenges. This center is not only a testament to their generosity, but also to the impact of our alumni who transform society and create a better world.



### 3. José Luis Íñigo González Borregos Arena, and fund for sports scholarships Guadalajara Campus

Committed to the comprehensive education of our students, we will begin the creation of an important milestone in the history of the Guadalajara Campus. The José Luis Íñigo González Borregos Arena, an extraordinary initiative that will be a space dedicated to promoting health and wellbeing throughout our student community. This space, which will be a meeting point for all those who participate and enjoy physical activity as part of their experience at Tec de Monterrey, will also be a venue where cultural events can be held. The Borregos Arena and the creation of a fund for sports scholarships for talented young people in athletic disciplines are possible thanks to our generous EXATEC, **Íñigo González**, Industrial and Systems Engineer, and **his family**, passionate about sports and promoter of a style of Healthy life. This space is a legacy in honor of Don José Luis González Íñigo, who is also EXATEC and Honorary Advisor of the Guadalajara Campus.





## AWARDS THAT TRANSFORM COMMUNITIES

The Institutional Awards allow us to promote a culture of generosity and the creation of a better society by recognizing people and organizations that stand out for reflecting both concepts in their work and career.

In the celebration of the 30th anniversary of the Eugenio Garza Sada Award, the humanistic leadership of people, the social entrepreneurship of organizations and the social innovation of students were recognized.

48 years after it was established, the Rómulo Garza Research and Innovation Award was awarded to professors and students for the scientific and research contributions made and the impact they generate in the communities.

Given the challenges that society is experiencing, it is essential to recognize and promote those people and organizations that contribute to the development of Mexico and its communities.

The entrepreneurship initiatives and research projects for the generation of knowledge and promotion of innovation recognized in the history of the awards are part of the legacies that were celebrated on the 80th anniversary of Tecnológico de Monterrey.

### Eugenio Garza Sada Award

Three decades after its creation, FEMSA and Tecnológico de Monterrey continue to honor the life, values and legacy of Don Eugenio Garza Sada, recognizing people with an exceptional business career who have contributed to the improvement of communities through their humanistic leadership.

Also we highlight the work of civil society organizations and students whose innovative initiatives have a direct impact on the transformation of communities and the strengthening of education and social development in Mexico.

On September 5, 2023, as a part of the 80th anniversary of the Tec and the 30th anniversary of this award, the recognition ceremony was held for the winners of the three categories.



### Winners of the Eugenio Garza Sada Award 2023

#### Humanist Business Leadership

Daniel Cárdenas Izábal is a prominent businessman and founder of 10 sustainability and social responsibility companies. Through his companies and organizations, such as Agrícola El Porvenir and Fundación Cárdenas, AC, he has been an active promoter of social benefit actions that have impacted more than 70,000 people.

He stands out for his promotion of education in the state of Sinaloa, being a member of the founding group of three university institutions, including the Tecnológico de Monterrey Sinaloa Campus.



### Social Entrepreneurship

Patronato Pro Zona Mazahua, AC is an organization founded by Jeannette Arriola Sánchez that, with more than 25 years of experience, has transformed the reality of more than 300,000 people from 11 indigenous ethnic groups in nine states of Mexico. Their contributions seek to raise the quality of life in a sustainable way and the resurgence of the indigenous peoples of Mexico.



### Student Social Innovation

MenstruAcción is a student group at the Tecnológico de Monterrey Querétaro Campus led by María José Villegas Martínez, Adriana and Paulina González González, it was created to raise awareness about menstrual education and ensure the rights associated with menstruation in the state of Querétaro. Through brigades and workshops they have impacted more than 2,000 women.



The 2023 Eugenio Garza Sada Award consisted of the sculpture “Inner Light”, a diploma and different economic incentives:

- Humanist Business Leadership: \$750,000 Mexican pesos that are donated to an institution selected by the winner. On this occasion it went to the Cárdenas Foundation, AC
- Social Entrepreneurship: \$750,000 Mexican pesos.
- Student Social Innovation: \$100,000 Mexican pesos to promote their project and \$400,000 Mexican pesos for an international training experience in a leading entrepreneurial ecosystem.

Throughout its 30 years, this award has recognized more than 70 winners, whose initiatives have benefited more than 8 million people from different Mexican communities.

Donations from FEMSA, Coca-Cola FEMSA, OXXO, FEMSA Negocios Estratégicos, FEMSA Salud, Digital@FEMSA and HEINEKEN México make the award and recognition possible.

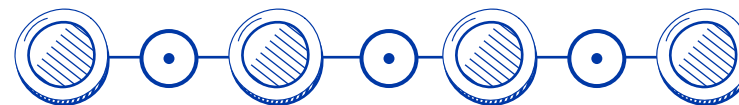

### Rómulo Garza Research and Innovation Award

In 1975, Xignux and Tecnológico de Monterrey established this award with the purpose of stimulating and promoting research in the academic and student community of our institution, promoting the generation of knowledge to solve the great challenges of society.

In 2023, the Rómulo Garza Research and Innovation Award ceremony was held on March 1, as part of the Tec Science Summit, an event that promotes the most relevant and impactful research projects developed by the Tecnológico de Monterrey. The award recognizes professors and student researchers from the Tec community who stand out for their scientific contribution.



## Winners of the Rómulo Garza Award

### Insignia Award: Alex Elías Zúñiga (Monterrey Campus)

He has a 35-year career as a research professor. He is currently leader of the Nanotechnology and Device Design Research Unit of the Institute of Advanced Materials for Sustainable Manufacturing. He is a member of the National System of Researchers, level 3, and of the Mexican Academy of Sciences.



### “Scientific Articles with High Impact Factor in Indexed Journals” category: Abrahan Mora (Puebla Campus), Nancy Ornelas Soto, Juan Antonio Torres Martínez and Jürgen Mahlkecht (Monterrey Campus).

All research professors from the School of Engineering and Sciences. Authors of the article “Tracking nitrate and sulfate sources in groundwater of an urbanized valley using a multitracer approach combined with a Bayesian isotope mixing model”, which stands out for the Field Weighted Citation Impact (FWCI) indicators of 8.53 and an Impact Factor (Cite Score ) of 19.8.

### “Research leading to Entrepreneurship” category: Grissel Trujillo de Santiago and Mario Moisés Álvarez (Monterrey Campus)

Both research professors from the School of Engineering and Sciences, winners for their “Chaotic Printing” entrepreneurship.

### The “Research leading to Entrepreneurship” category was recognized for the first time in this edition of the award.

### Acknowledgments in the categories of research projects by students:

- **PrepaTec:** Iris Giselle Balderas from PrepaTec Estado de México Campus, for her project “Mathematical modeling to personalize and innovate the learning process.”
- **Undergraduate:** Jairo Enrique Ramírez and Arely Anguiano from Monterrey Campus for the project “Real-Time Mexican Sign Language Interpretation Using CNN and HMM”.
- **Graduate:** Melissa Eugenia Diago PhD student in Engineering Sciences at Querétaro Campus, for the project “Inbuilding measurement-based radio propagation modeling using a geostatistical interpolation technique”.



The Rómulo Garza Research and Innovation Award consisted of the “RG” sculpture and different economic incentives:

- Insignia Award: \$400,000 Mexican pesos.
- “Scientific Articles with High Impact Factor in Indexed Journals” Category: \$200,000 Mexican pesos.
- “Research leading to Entrepreneurship” category: \$200,000 Mexican pesos.
- Students for Research Projects with Innovation Components: \$50,000 Mexican pesos for each category, in its three levels.

The financial incentives for the winners, as well as operating expenses, are covered with the returns generated by the prize fund, created by Xignux.

## SORTEOS TEC

### 2023: 10 years of supporting the Leaders of Tomorrow

For Sorteos Tec, 2023 meant a year of achieved goals and evolution:

- **Income of 1,700 million pesos, the highest in 15 years.**
- **Record remainder with \$282 million, the highest in 15 years.**
- **For the first time, a full scholarship was granted to an incoming generation: The 10th Generation of Leaders of Tomorrow, with 221 young people from all over Mexico.**

During this period, 62 raffles were held, of which 59 reported total sales. In addition, this year innovations in several products stand out, such as the new Sorteo Efectivo Plus Especial and the relaunch of the Sorteo Gana Ya, with digital prizes focused on the younger generations, as well as the launch of the Sorteo Dinero de x Vida in digital version.

At the end of this year, Sorteos Tec's portfolio amounts to 12 products.

This year, sales through digital media represented 47% of total income. Likewise, the number of volunteer collaborators increased from 150,521 to 164,882 people. Their support was instrumental in the sale of more than 3.4 million tickets.

This cycle was concluded with an increase in the direct remainder of 10% compared to the previous year (\$282 vs. \$257 million), allocated entirely to financing the Tec de Monterrey Leaders of Tomorrow program.

## distritotec

**distritotec** is an urban community that seeks to transform lives through the power of encounters. Promoted by Tec de Monterrey, distritotec collaborates so that the quality of life in the environment and the capacity for innovation mutually nourish each other.

It acts in four axes:

**Generate**  
meeting spaces

**Boost**  
an innovative community

**Promote**  
a sustainable environment

**Give life**  
to the district through coexistence and art

### Distritotec progress in 2023:

#### Community boost in distritotec

highlighting achievements and challenges to improve the community and promote active citizen participation.

#### Educational collaboration with public schools

Progress with diagnoses of school environments, training for Mobility Promoters and the rehabilitation of 2 schools.

#### Revitalization of public spaces with Callejero

strengthening community connection, attracting more than 2,600 attendees

#### Transformer project in Luis Elizondo – Section 2

seeking to improve mobility and safety, prioritizing accessibility and local wellbeing.

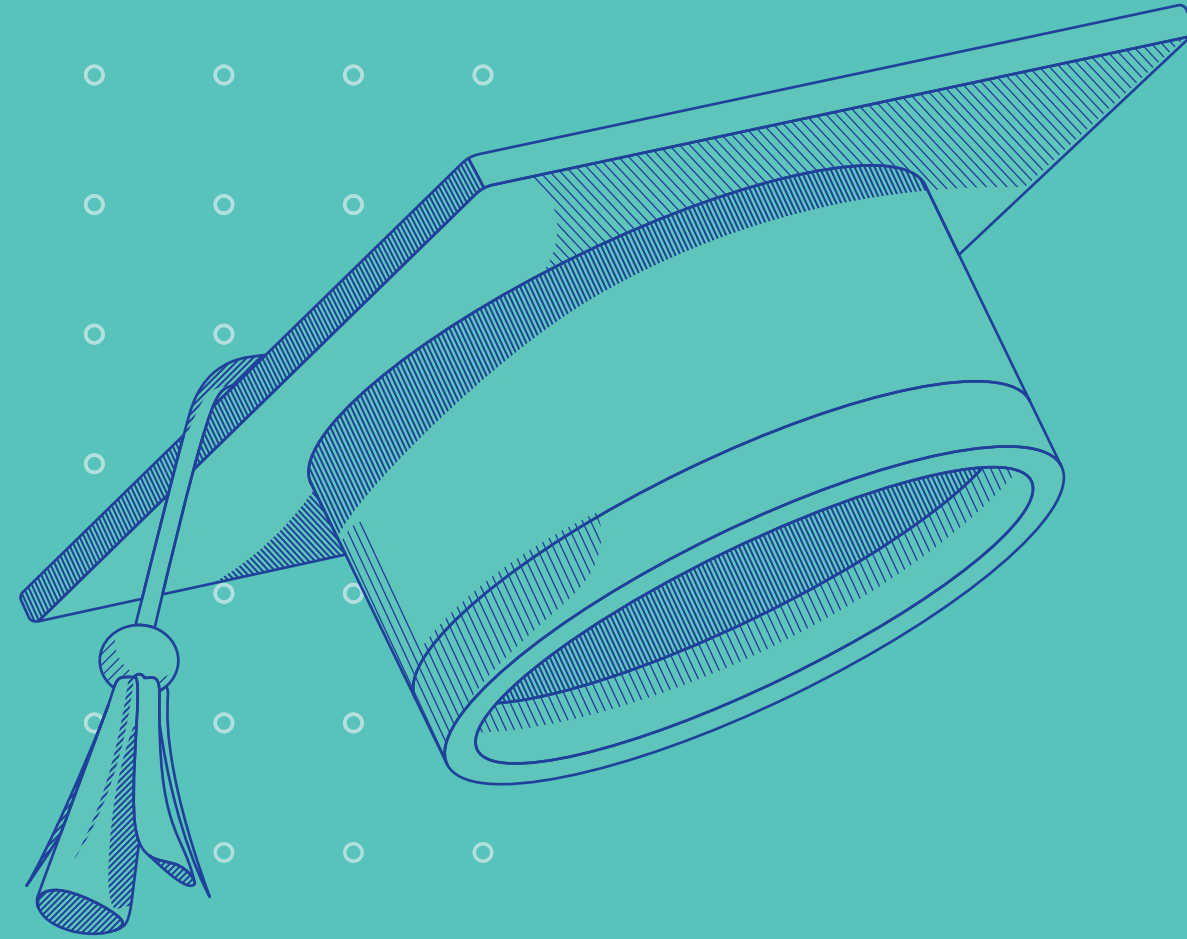

Alumni



# Relations with alumni

- In 80 years, the EXATEC community has generated 3.2 million jobs and created 220,000 companies, according to an impact study carried out by QS.
- 23 alumni have received the EXATEC Trajectory Award and the EXATEC Merit Award.
- The 80th anniversary boosted the growth in the relationship with our alumni, achieving the participation of more than 54,000 graduates, of which more than 2,300 participated in EXATEC groups' events. The meeting between the Board of Directors and graduates in Puebla, Guadalajara and Mexico City stands out. As well as the meeting in Houston, Texas with Ricardo Saldívar and David Garza, and the meetings in Madrid, Washington and Singapore.

In 2023, the celebrations for Tec's 80th anniversary amplified opportunities to strengthen ties with the alumni community. In addition, initiatives were promoted such as the Economic and Social Impact Study carried out by the English rankings company Quacquarelli Symonds (QS), the EXATEC Awards, among others.



## ALUMNI'S IMPACT

Result of the economic and social impact study carried out by QS:

The English ranking company Quacquarelli Symonds (QS), in collaboration with the Tecnológico de Monterrey, carried out a study to measure the economic and social impact that the alumni have generated since Tec's foundation. In 80 years, graduates have achieved:



### EXATEC's career path

To follow up on the EXATEC's career path, employability surveys are carried out. In 2023:



Employment rate three months after graduation

### Professional Path



Employment rate 5 years after graduation

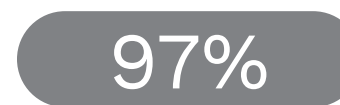

Employment rate 25 years after graduation

### 25 years after graduation

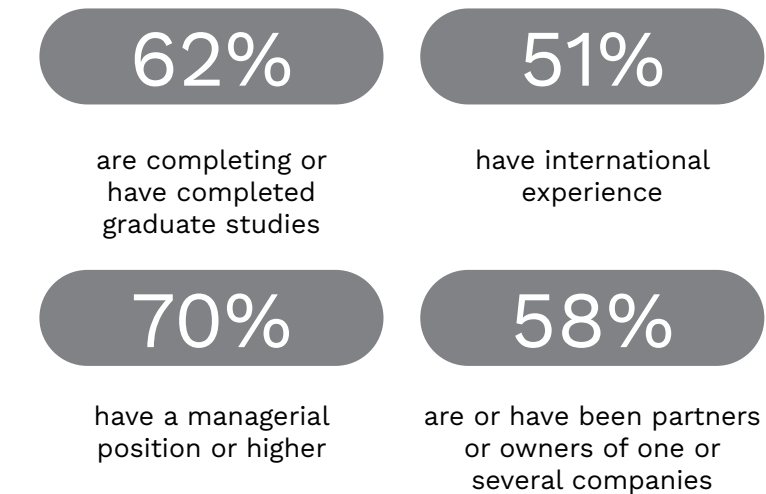



## EXATEC AWARDS

During this period, through the EXATEC Trajectory Award and the EXATEC Merit Award, we recognized 23 alumni for the mark they have left in their community and their transcendent work.

José Luis González Íñigo (IQA'66) received the EXATEC Trajectory Award.



The 22 winners of the EXATEC Merit Award were recognized at a ceremony held on their respective campuses.

Name	Degree	Campus or School that gave the award
Eduardo Tricio Haro	IAZ'85	Laguna Campus
Francisco Javier Buenrostro Gándara	LSC'79	Aguascalientes Campus
Carlos Antonio Carvajal Lechuga	ARQ'72	Chihuahua Campus
José María Pablos González	IAA'74	Sinaloa Campus
Alfonso Reina Villegas	IC'76	Sonora Norte Campus
Mario Orozco Arena	IQS'80	León Campus
Humberto Schwarzbeck Noriega	PrepaTec'72, LEC'78	Ciudad Obregón Campus
Héctor Manuel Jaramillo López	PrepaTec'01, IC'04	Zacatecas Campus
Jorge Alberto Urías Cantú	IC'74	Ciudad Juárez Campus
Juan Carlos Díaz Garmendia	IBP'90	Irapuato Campus
José Luis Mandiola Totoricagüena	CP'83	Chiapas Campus
Mauricio Sulaimán Saldívar	LAE'94	CDMX Region
Sergio Amín Chufani Abarca	IC'88	Querétaro Campus
José Luis Romo Cruz	PrepaTec'93	Hidalgo Campus
Iván Alberto Elizondo Cortina	CP'93	Cuernavaca Campus
Juan Antonio Solbes Simón	CP'88, MBA'14	Tampico Campus
Imelda Elizalde Martínez	LCC'90	San Luis Potosí Campus
Gustavo Alfredo Cárdenas Villafaña	PrepaTec'93, LAE'97, MA'05	Toluca Campus
Felipe Manuel Martínez Pérez Vasconcelos	IME'74	Puebla Campus
Enrique Javier Garza Cantú	LAE'93	Saltillo Campus
Silvia Lucía Dávila Kreimerman	MNE'97	EGADE Business School
Galia Borja Gómez	MEK'14	School of Government and Public Transformation

## CELEBRATION OF ALUMNI

As part of the 80th anniversary of the Institution, a series of meetings were held to celebrate among EXATEC the Tec de Monterrey's legacies that transcend.

The Annual Meeting of Presidents of EXATEC Associations and Clubs brought together 52 presidents who lead various initiatives in their communities inside and outside of Mexico.



The Board of Directors of the Institution had the opportunity to connect with the EXATEC communities in Puebla, Guadalajara and Mexico City, through the Meet and Greet events.



Ricardo Saldívar Escajadillo, President of the Board of Trustees, David Garza Salazar, President and the Leadership Team, held a meeting in Houston, Texas, organized to connect with alumni from Houston, Dallas, Austin and San Antonio.

David Garza Salazar and members of the directive team had meetings with alumni in Madrid, Washington and Singapore.



## EXATEC GROUPS

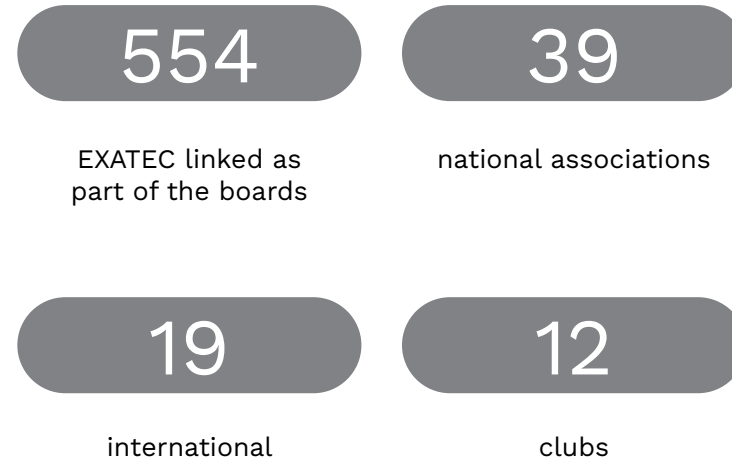

This year, we established the EXATEC International Relations and EXATEC Michoacán groups, as well as the EXATEC Swimming Club.

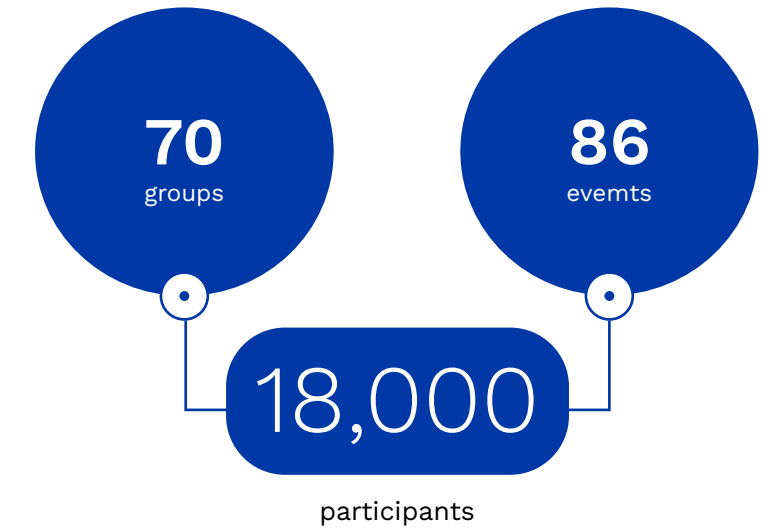



## Homecoming

30 reunion events with their generation colleagues and professors held on 23 campuses, with the participation of more than 4,300 EXATEC.

## EXATEC Generation Leader

+2,400 generation leaders actively participated in 23 campuses, chosen by their generation colleagues as they distinguished themselves for their leadership, communication and integration skills.

## EXATEC Blue Open Golf Tour, an event with a cause

12 campuses held events with more than 1,300 participants, resulting in more than 4.8 million Mexican pesos raised to support scholarship programs, including Leaders of Tomorrow.

## Culture of generosity in future EXATEC

For the first time, students from 20 campuses came together to collaborate on various activities and projects in order to secure a scholarship for a Leader of Tomorrow student. In addition, the theme of reciprocity and generosity was incorporated into the Tec Life Plan class and the Tec Week with Human Sense was designed.

Indicator	2022	2023	Δ
EXATEC that integrate the community <sup>(1)</sup>	341,539	460,293	26%
EXATEC participating Events <sup>(2)</sup>	23,343	54,151	57%
Contactable EXATEC <sup>(3)</sup>	N/A <sup>(3)</sup>	163,235	NA
Associations active in Mexico	35	39	10%
Active associations abroad	19	19	0%
EXATEC active clubs	13	12	-8%
EXATEC donating	5,862	6,588	11%

<sup>(1)</sup> Starting in 2023, High School graduates are counted as EXATEC.

<sup>(2)</sup> Carried out on 25 campuses, EGADE Business School, School of Government and Public Transformation and online programs and graduate degrees in the area of Digital Education. The growth is due to the participation of a greater number of alumni for the 80th anniversary of Tecnológico de Monterrey.

<sup>(3)</sup> Without prior information. The contactable criterion was redefined: a contactable alumni is one who opens at least one email in the current academic period.

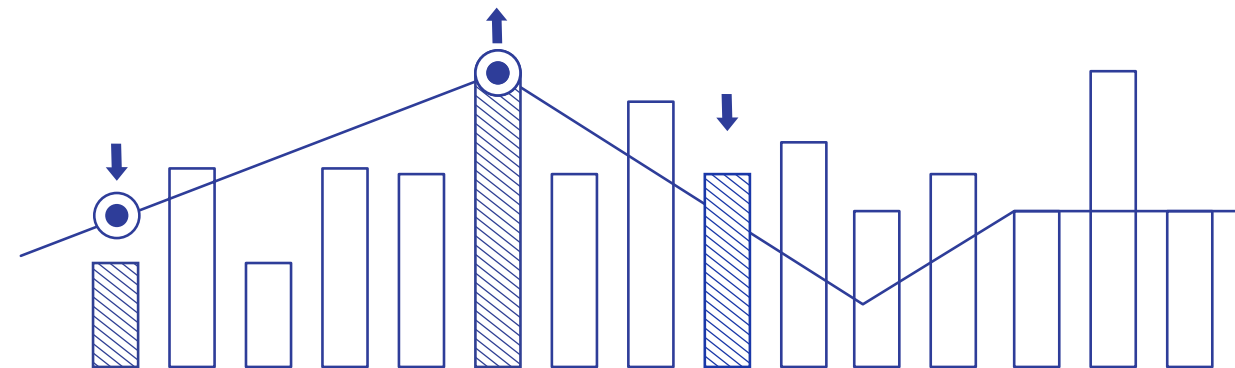

# TecSalud

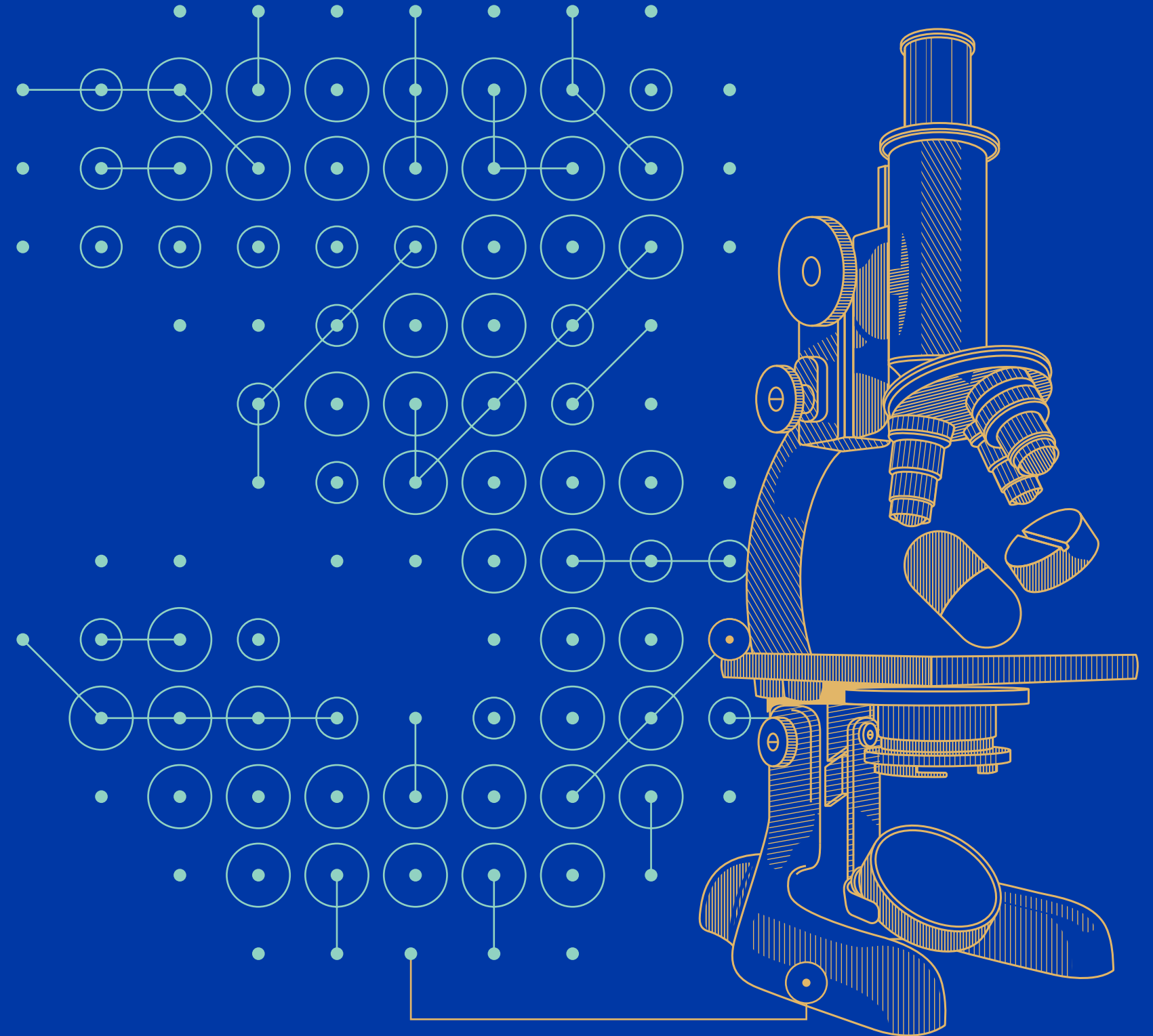

# Health leadership that transforms

TecSalud advances and consolidates itself as a health leader in Mexico thanks to its contribution to the transformation of medical practice and its patient-centered culture of quality and safety.

This year, **TecSalud hosted the event The Future Role of Academic Health Centers: Leadership and Growth, of the Association of Academic Medical Centers. There, the importance of academic medical centers** was highlighted and the need that more of them exist, which should promote not only patient care, but also the promotion of research, education and social development in a comprehensive manner.

## QUALITY OF CARE

103,348

patients treated at Academic Medical Centers

89,324

patients treated with out-patient services

14,024

hospitalized patients

226,593

consultations offered through the Health Institutes

8,636

surgeries

72

transplants

TecSalud's San José and Zambrano Hellion Hospitals performed outstandingly in various **national and international rankings**, in which they were recognized for their quality and excellence in medical care. These stand out:

Hospitals ranking according to Funsalud, Blutitude and Expansión magazine:



#4

Zambrano Hellion Hospital



#7

San José Hospital

Top 3 in medical specialties:

#1

In México

**ZHH** Cardiology and Heart Surgery, Gynecology and Obstetrics, Urology, Orthopedics and Traumatology.

**SJH** Emergency Medicine, Plastic and Reconstructive Surgery

#2

In México

**ZHH** Otorhinolaryngology and Head and Neck Surgery, Critical Care Medicine, Neurology and Neurosurgery, Gastroenterology and Gastric Surgery, Endocrinology, Pulmonology, Plastic and Reconstructive Surgery and Emergency Medicine.

#3

In México

**ZHH** Oncology and Pediatrics.

**SJH** Gynecology and Obstetrics, Urology, Critical Care Medicine, Nephrology, Otorhinolaryngology and Head and Neck Surgery and Orthopedics and Traumatology.

“The Best Hospitals in Latin America 2023”, rankings from América Economía publishing house



#2

In México



#3

In México



#12

In LATAM



#20

In LATAM

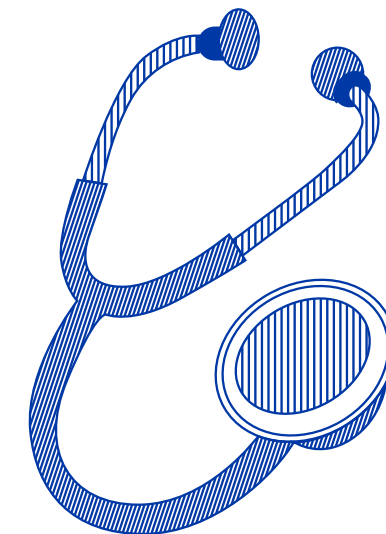

TecSalud Nursing officially achieved the **Pathway to Excellence®** designation, which recognizes its commitment to health care within the organization.



The designation was awarded by the American Nurses Credentialing Center (ANCC), a subsidiary of the American Nurses Association. TecSalud became the only organization in Mexico and Latin America to obtain the Pathway to Excellence® designation.



**TecSalud única institución designada con la certificación Pathway to Excellence® en México y Latinoamérica.**



In addition, TecSalud has obtained various accreditations such as the Quality Assurance Program (PACAL), the National Blood Transfusion Center Program, the LICON Quality Program, the QUALITAS External Quality Control, the BLUE BELL External Quality Control and the Distinctive H, demonstrating its commitment to quality and safety in the medical care provided to its patients.

Continuing in the mission of transforming health in Mexico, TecSalud acquired a new Positron Emission Tomography - Computed Tomography (PET-CT) equipment, with the aim of offering patients and healthcare professionals the best image quality in the diagnosis of diseases.



## FOCUS ON HIGH SPECIALTY

TecSalud hospitals offer a variable set of clinical-surgical specialties aimed at treating conditions of high diagnostic-therapeutic complexity, and seek at all times to ensure quality and patient safety. This year we continue to strengthen our highly specialized strategic areas in **cardiology, oncology, neurology and transplants.**

In this sense, the launch of the first Interdisciplinary Brain Tumor Center in Mexico stands out, located on the eighth floor of the Zambrano Hellion Hospital, as part of the 2nd Symposium “News in Neurology and Neurosurgery”, comprised of neurosurgeons, oncologists, radiologists, pathologists, among other specialists.

The Zambrano Hellion Hospital received the prestigious **Get With The Guidelines® - Coronary Artery Disease quality award, Silver Plus level, from the American Heart Association (AHA)**. This recognition is the result of continued commitment to excellence in healthcare for patients affected by coronary artery disease, heart attacks and chest pain.

TecSalud's Zambrano Hellion Hospital became the **first private hospital in Mexico** to apply gene therapy on a private patient. The treatment was successfully administered in a pediatric patient suffering from spinal muscular atrophy.

TecSalud **hosted the Cardio simulations** camp for high school students interested in the School of Medicine and Health Sciences.



Likewise, the **First International Symposium on Cardiogenic Shock and Heart Failure** was held in Cancún, Quintana Roo, in which the latest advances, challenges and innovative approaches in the treatment of these conditions were discussed.

Meanwhile, with the objective of training and certifying specialist doctors in intensive care, cardiology, pulmonology, as well as healthcare professionals and nurses, the Certification Course in Extracorporeal Life Support was carried out. This course is endorsed by the Extracorporeal Life Support Organization (ELSO) and has the requirements to obtain certification in extracorporeal membrane oxygenation or ECMO.

## INNOVATIVE ACADEMIC MODEL

TecSalud has an innovative academic model that educate health leaders in Mexico to develop the medicine and health care of the future. It offers, through its Academic Medical Centers, a unique educational experience that includes the best specialists in medicine and health sciences as professors.

TecSalud created the living donor program for solid organs or portions (liver and kidney) which offers advantages such as avoiding waiting lists, prolonging the patient's life and improving the function of the damaged organ.

Also this year, in order to address the challenges of cancer care in health systems around the world, the Lancet Commission on Cancer and Health Systems met at the facilities of the Tec de Monterrey, CDMX Campus. Around 100 scientists from 24 countries analyzed and presented the changes in public policies that need to be made in health systems to improve the life expectancy of patients.

439

undergraduate students rotating in our Academic Medical Centers

416

residents rotating in our Academic Medical Centers

### Specialties with residents:

Specialty of Ophthalmology, Medicine for the Critically Ill, General Surgery, Pediatrics, Gynecology and Obstetrics, Internal Medicine, Cardiology, Anesthesiology, Quality Care, Neonatology, Radiology and imaging, Pediatric Neurology, Urology, Neurology, Geriatrics , Pathological anatomy.





## EXPANSION PROJECTS

To reaffirm the commitment to improve the level of private medicine in the country, offer excellence in medical care and share good practices, this year the seven hospitals of the **Joya Medical Group**, a referent in medicine in the North Coast of the State of Jalisco and Riviera Nayarita region, joined the **TecSalud Network**. The **La Concepción Hospital Center**, located in Saltillo, Coahuila, and the **Sharp Mazatlán Hospital** also joined.

Also noteworthy is the opening of the second **Primary Care Clinic** in Cumbres, which adds to the community outreach and positioning strategy of TecSalud.

**11** hospitals in total in the TecSalud Network.

This year **Healthec® by TecSalud** began operations, with its first specialty outpatient clinic in Mexico City. This will provide care with the highest standards of quality and safety, with a focus on preventive and personalized medicine according to the needs of each patient.



Healthec® by TecSalud has more than 30 doctors from various specialties such as: cardiology, orthopedics, rehabilitation, urology, pediatrics, nutrition, endocrinology, gastroenterology, otorhinolaryngology, psychology, internal medicine and nephrology.

TecSalud signed a collaboration **agreement with Sociedad Cuauhtémoc y Famosa (SCYF)** to consolidate a medical alliance between both institutions for the benefit of Monterrey society. The objective of this alliance is to expand first, second and third level (high specialty) medical services for SCYF employees and their immediate family members.



## CUTTING EDGE RESEARCH

TecSalud’s leadership is also reflected in research, a field in which it works to contribute to science by searching for solutions to eradicate, treat and prevent diseases through the development of various basic, translational and clinical research protocols.

**+14**

Clinical research protocols with pharmaceutical industry laboratories

**Name of the industries:**

Novartis, Tesaro Inc, Janssen Research and Development LLC, Celcuity Inc, Eli Lilly, Arcus Biosciences and Atea Pharmaceuticals.

**25**

Participants in clinical research protocols

**Focus:**

They focused on the study of the treatment of oncological, gastrointestinal, cardiological and infectious diseases.

**8**

original protocols

**116**

participants in original protocols

Additionally, we highlight the development of original clinical protocols such as the **Beyond Protocol**, which researches changes in cardiac function in overweight patients undergoing weight loss treatment. And the protocol of **Medical Therapies through the use of CBD**, in collaboration with **Cardiol**, which seeks to develop clinical studies and protocols related to heart failure.

## WELLBEING, PREVENTION AND LONGEVITY

Heading towards 2025, the Institution continues to promote a cultural movement of Wellbeing, Prevention and Longevity.

As part of this strategy, a collaboration agreement has been established between TecSalud and the municipality of San Pedro Garza García, with the purpose of providing access to health prevention programs to the community.

These programs were designed to help people adopt healthy habits that have a positive impact on their quality of life.



In this sense, group programs such as “One step at a time” were implemented, which aims to connect the health experience of TecSalud employees from the initial (integrative) evaluation and promote healthy habits.

Likewise, we seek to inform and promote the health of the community through webinars. This year, 16 programs were held that were watched by around 7,286 viewers.

**30**

wellness ambassadors in the organization

**52**

initiatives implemented to promote wellbeing in areas such as nutrition, physical activity and mental health

**6,724**

employees have participated in physical activities and wellness challenges

**3,381**

people in total have participated in the Wellbeing, Prevention and Longevity programs



## TECSALUD FOUNDATION

This year, the TecSalud Foundation provided medical care to approximately **27,245 patients** in the community, through its different programs.

The Integral Health Center (CeSI, in Spanish), located in the municipality of Santa Catarina, Nuevo León, is comprised of the Ophthalmology Institute of the TecSalud Foundation, the Primary Care Clinic, the Women's Care Unit for breast cancer diagnosis and the Academic Center for Comprehensive Wellbeing Care (CAABI, in Spanish).

In addition, recently the CeSI focuses on hearing health care.

Thanks to the support of the Protexa Foundation, through the Academic Care Center in Otorhinolaryngology, which was inaugurated at the end of this year.

At CeSI, health services are offered at a social price, with the quality and infrastructure that distinguishes TecSalud. In this cycle the following stand out:

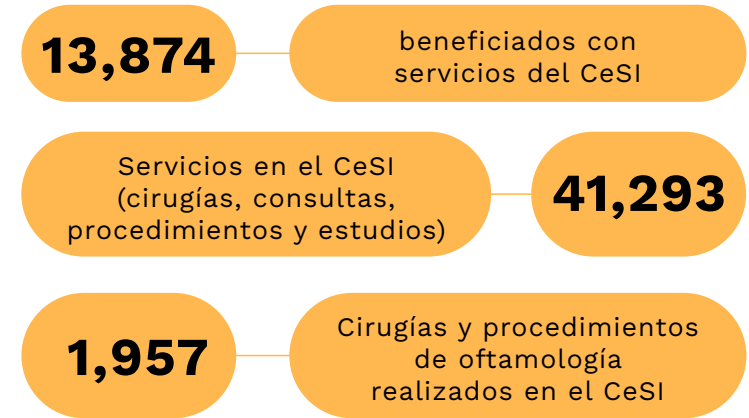

Through the PREVER Conference Program, a culture of health education is created and fostered for less privileged communities.

**In 2023, 130 medical professors and health professionals from TecSalud gave 51 conferences impacting 12,532 attendees.**

The TecSalud Foundation has funds to cover medical and hospital care for social patients (people who meet pre-established requirements to benefit)..



The actions of the TecSalud Foundation are carried out thanks to the altruistic and committed spirit of the TecSalud medical professors, residents and students of the School of Medicine and Health Sciences of the Tecnológico de Monterrey.

**In 2023, 34 medical professors from TecSalud participated, as well as 288 students and residents from the School of Medicine and Health Sciences of the Tecnológico de Monterrey.**

They generously contributed their time and knowledge to contribute to the goal of transforming medical care in the community and continuing the leadership of TecSalud.



# Tecmilenio

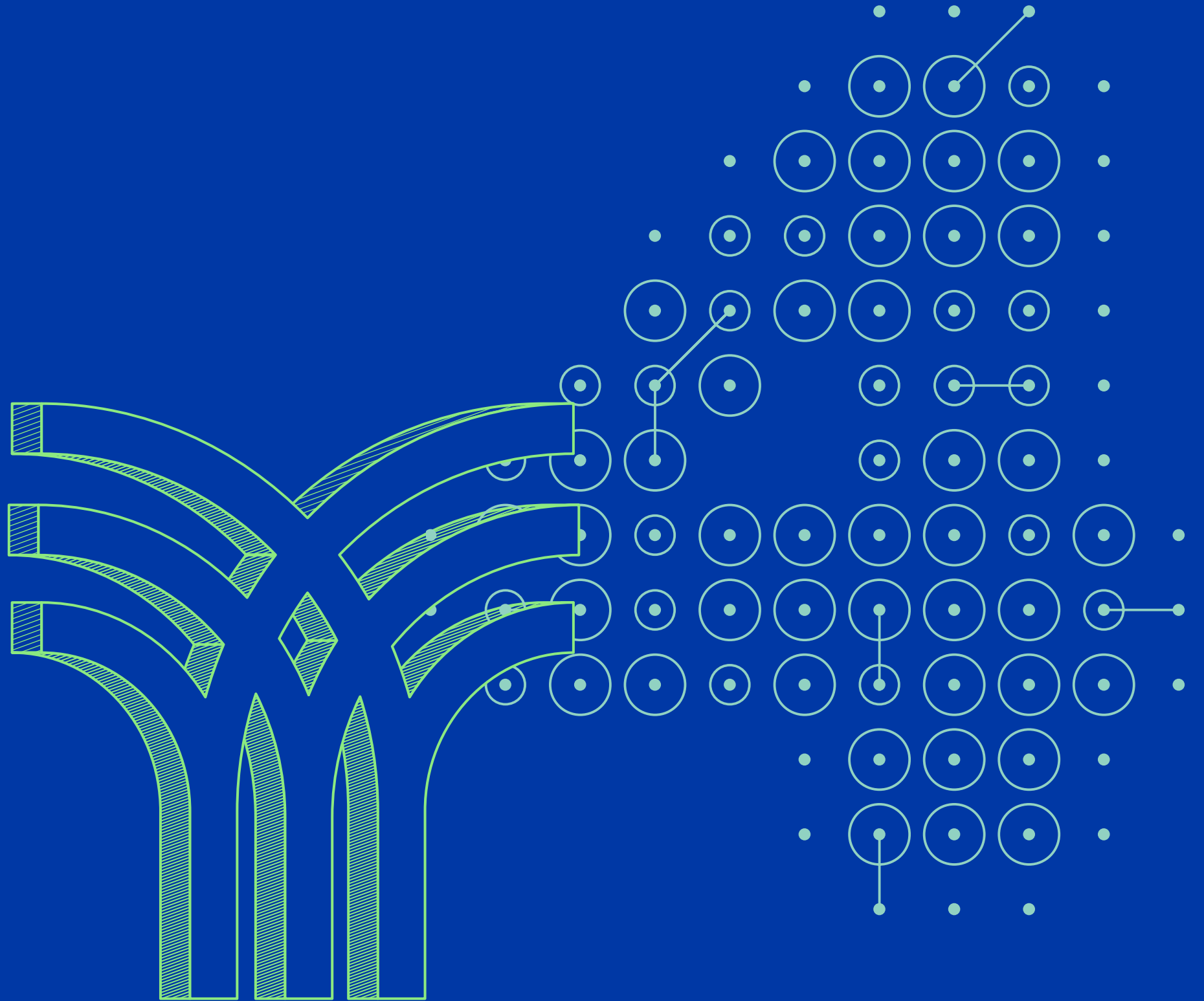

# Educational innovation in the digital age: forging a sustainable future



Innovation, adaptation and evolution have been part of Tecmilenio’s DNA since its inception. In 2023, we continue with a determined focus on the future.

In an ever-changing world, education must be at the forefront of transformation. Understanding the importance of digital skills in the future of work and the need for flexibility in teaching, Tecmilenio reaffirmed its commitment to preparing its students not only for the present, but for a tomorrow that is still being written.

This year, for the first time, Tecmilenio served more than 100,000 students and learners in formal and open education, and we launched the programs Associate Undergraduate, Executive Undergraduate and Graduate.

Tecmilenio continues with its commitment to a more accessible high-quality education and in the face of the changing environment, it demonstrated its capacity for innovation and adaptability by consolidating strategic alliances, focusing on the development of digital skills, and promoting a differentiated approach to comprehensive wellbeing.

In addition, the institution managed to exceed its philanthropy goals, collecting donations that positively impacted the lives of numerous learners.

## FORMAL EDUCATION

In numbers

62,536

students

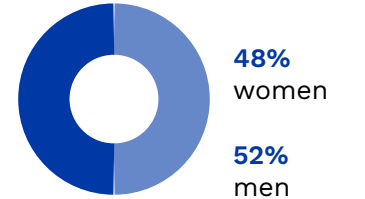

19,865

High School



5,159

Professors

17,135

Undergraduate



29

Campuses

11,868

Executive Undergraduate



12

Connect spaces

13,668

Master Degree



85%

of students have some financial support



### Associate Undergraduate

Seeking to expand the relevance of our offer to different segments of the population, this year, we launched Associate Undergraduate (PA, in Spanish) careers under the CIMA model. This new format offers greater flexibility and the possibility of continuing studies for people who prioritize their work but want to study to continue developing, allowing them to obtain a degree in two years and even be able to join undergraduate careers.

The first four PA programs we launched are Business Administration, Health Administration, Software Development, and Tourism.

These programs include accompaniment, soft skills development, English classes, practical application projects and certificates with digital badges.

### Remote and Connect model

The Connect Spaces are innovative learning hubs, specially designed for executive and graduate programs, where you can take virtual or in-person classes, connect and collaborate with more students to grow professionally.

This year, remote education enrollment grew 5.2% and 8% in the hybrid Connect format, thanks to the launch of new programs and the opening of four new spaces: Las Torres (Mty), León (Gto), Santa Fe (CDMX) and Satellite (Edomex). With this there are now 12 Connect Spaces strategically located to positively impact a greater number of learners.



### Rankings and accreditations

Tecmilenio reaffirmed its commitment to academic quality by renewing its accreditation as a member of FIMPES, the highest standard for private universities in Mexico.

Additionally, the online Master degree in Business with Finance program advanced to position:

**#11** in the prestigious Online Higher Education (FSO, in Spanish) ranking, consolidating the institution's reputation in online education.

Regarding its presence in international events, Tecmilenio participated in THE LATM Summit forum and in QS Higher Ed: Americas Summit. It was also a finalist in the EQUAA Awards of Guatemala in the Innovation category, "Design Driven Education."

These achievements strengthen Tecmilenio's position in higher education in Mexico and Latin America.





## LEARNING FOR LIFE

Tecmilenio seeks to guide millions of learners in the different stages of life. The goal is to increase their wellbeing, professional success and positive impact on society. To this end, the offer of open education with a focus on lifelong learning was expanded.

### Skilling Center

The Tecmilenio Competence Center was born as a place where companies seeking trained talent and people seeking to acquire, increase or update their skills converge.

In the quest to disseminate a clearer offer of technical and human skills to more learners and to transmit its mission more clearly, this year the name of the Competence Center was changed to Skilling Center.

Thus, it grew 34% compared to 2022, thanks to the implementation of strategic projects such as Skilling in a Box, memberships and a positioning campaign in digital skilling, reaching more than **52,229** learners in 2023.

We launched a new affordable Membership model, with which learners of all ages can personalize their learning paths

**+5,000** learners impacted.

The diagnosis of skills is key so that learners can self-assess their level and obtain personalized recommendations to update, acquire or increase their skills.

This year, 78 types of diagnoses were applied on more than 10,000 occasions to different audiences, for example, the technical English diagnosis, which is critical to enhance the benefits of Digital Skilling.

The Skilling Center, formerly called the Tecmilenio Competence Center, grew 34% this year and reached 52,229 learners.

### Digital Skilling

This year we continue with the objective of consolidating the CIMA strategy to close the gap in digital skills that are highly in demand in the market.

With a robust offering of

**+ 250**

of its own programs and in alliance with different organizations, Tecmilenio has a strength in certifications and bootcamps that promote the development of digital programming and technology design skills, as well as the management of these new technological tools. During the period, 3,000 learners were served in these programs, including 696 international learners.

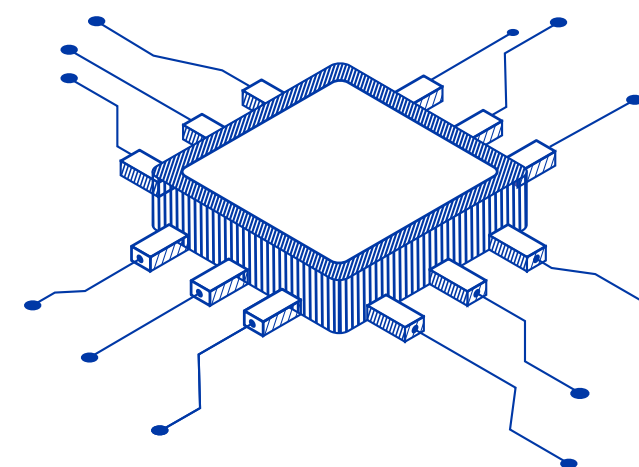

## INTERNATIONALIZATION AND STRATEGIC ALLIANCES

To expand the impact of Tecmilenio and bring the educational offer to other markets, as well as to complement the value offer, strategic alliances were established with institutions such as Alamo Colleges District and Arizona State University. This year stands out:



### Alliances

- The launch of the Nursing Pathway in alliance with Alamo Colleges District to upskill Mexican nurses to enter the labor market in the United States.
- Arizona State University (ASU): +100 learners impacted by the Learning Enterprise portfolio through the Skilling Center. Signing of an agreement to promote English for Semiconductors to the Tecmilenio community.
- Strengthening the alliance with InStride for positioning in the business to business (B2B) market in the United States, with +150 learners impacted in online and Continuing Education programs.
- Launch of Tecmilenio-in-a-box, to position the Tecmilenio portfolio in LATAM universities (for example, CENFOTEC, Universidad de Santo Tomás, Tecnológico del Espíritu Santo).

## EDUCATION FOR COMPANIES

Tecmilenio has developed an education model in conjunction with companies so that, together with their collaborators, they can acquire the necessary skills to face the future successfully.

This model includes:

- 1 **Acquire**, update and increase the skills and abilities of company collaborators.
- 2 **Co-design** of unique learning experiences aligned to strategy.
- 3 **High-impact solutions on two fronts:** in the strategic indicators of the organizations and in the comprehensive transfer of competencies in the collaborators.

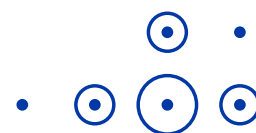

Impact achieved in 2023:

**+26,040** learners from Top, Mid and SMB (Small and Midsize) companies

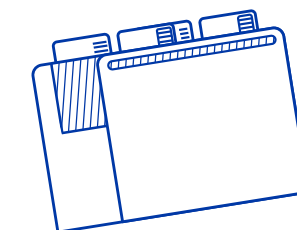

**60** leading companies in the Mexican market, including



**28** transnationals

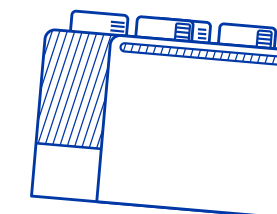

**+45** custom co-created programs



**+4,500** agreements signed with companies

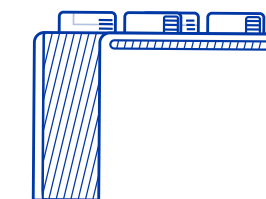

**+13,000** collaborators who today benefit from Tecmilenio programs

Likewise, we generated impact with leadership and wellbeing programs in the operational and middle management layers of the organizations, with an NPS equal to 73.

## VIVE: STUDENT EXPERIENCE

VIVE promotes comprehensive educational development through activities and events that contribute to student success, aligned to five pillars that enrich the student experience: Student Groups, Art and Culture, Athletics, eSports and Social Impact.

This year focused on providing experiences through large-format events, attracting students from all campuses to the cities where they were held. The competitive level was strengthened in the five pillars of the experience, giving place to Representative Teams and a strong sense of Hawk Pride with national and international recognition.

The number of young and adult participants increased in face-to-face, Online and Connect formats, achieving the participation of more than 42,000 students of all formats and levels in sports, cultural, eSports, leadership and connection activities.

### Student leadership



Meeting of Captains – High School: +220 students from 28 campuses attended Tecmilenio Puebla to develop leadership skills and be invested as Captains of their society. 97% satisfaction.

Meeting of Student Groups – Semester Undergraduate: the first Student Federation was created at the national level (FETECMI) and 28 Student Councils were formed, with +500 students nationwide in a hybrid manner.

### Large-format events



National sports competition (Interhalcones); 620 athletes from 23 campuses within 6 sports disciplines.

Tecmilenio’s musical magazine “Halcón: Emoción a través de tus sentidos” was presented for the first time, with the participation of High School and Semester Undergraduate students. More than 3,000 people attended in 6 functions.

Intersocieties: High School students represented their societies, groups to which all students in this grade belong, completing recreational challenges and applying their different character strengths. +400 students participated.

### Scalable experience



The production of an offer of four new VIVE Workshops allowed more than 12 thousand Executive Undergraduate and Graduate students to enrich their student experience asynchronously.

### Hawk Pride



It has 138 Representative Teams (Athletics, Art and Culture and eSports) in which 1,647 students participate.







## COMPETITIONS AND AWARDS

This year, Tecmilenio students of all levels stood out in various competitions in which they won numerous awards, including:

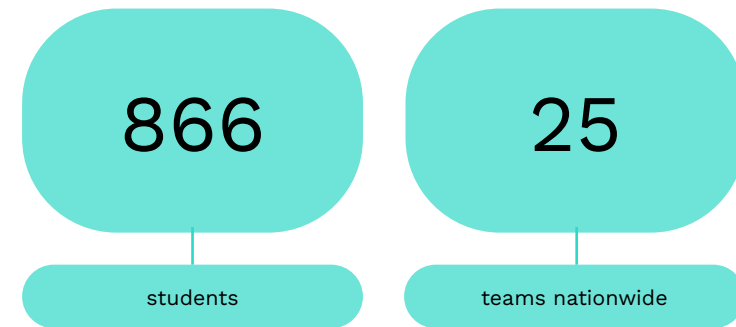
### FIRST World Robotics Competition



 3  
passes to the FIRST Robotics Competition (FRC) world championship.

 1  
pass to the FIRST Tech Challenge (FTC) world championship.

 6  
award-winning teams in FRC and FTC.

 2  
awards in FIRST Championship for the Devolt team from Chihuahua Campus.



*In the FIRST Robotics Competition (FRC) we received the Rookie All Star Archimedes Division award, and in the FIRST Tech Challenge (FTC) the Connect Award Division.*

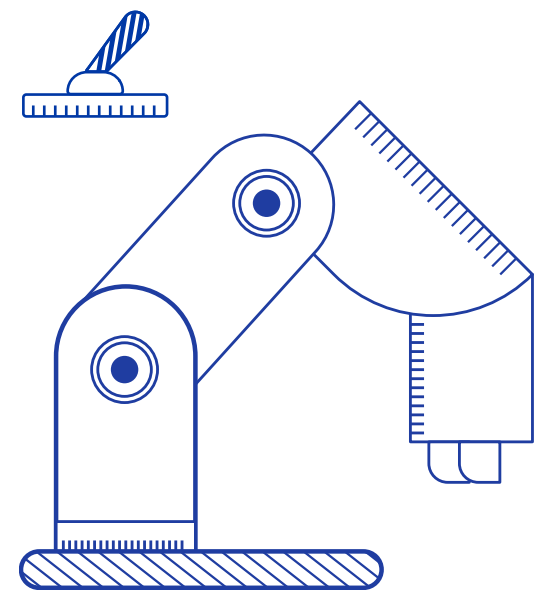

## ENACTUS

Global entrepreneurship organization, where participated:

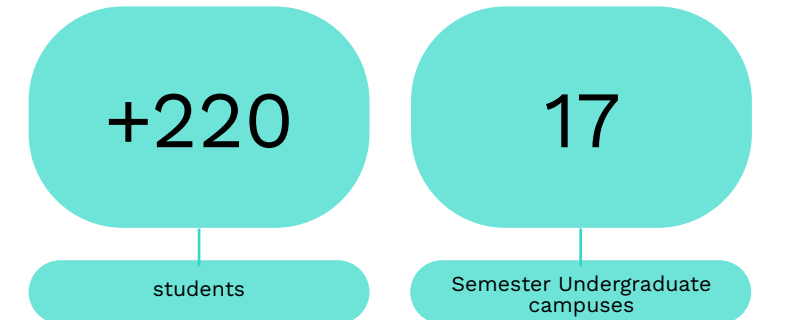

 2°  
national place for Tecmilenio Culiacán

 3  
more awards within the different categories

 6  
recognitions for the campuses





## STUDENT WELLBEING

This year an evaluation instrument was developed, with a pilot with the participation of +500 students. This pilot has paved the way for its implementation at scale in 2024.

In addition to this, a successful model of care for mental health cases was presented during the 2023 NASPA (National Association of Student Personnel Administrators Strategies) Congress. We also participated in the 1st National Summit of Health Talent Trainers, organized by the AMFEM (Mexican Association of Medical Faculties.) It is especially notable that Tecmilenio, despite not offering a degree in Medicine, was the only university invited.

Your Wellness Network provided more than 27,000 services that impacted nearly 19,000 users of all levels.

## TECMILENIO COMMUNITY

### EXATECMI

 **13,399** graduates have joined the community

**+173,000** graduates in total

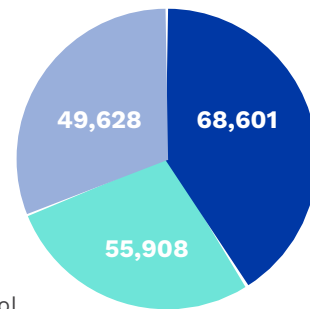

● Undergraduate ● Graduate ● High School



**89%** employability upon graduation.

This year, Punto EXATECMI, a private digital community for alumni, was successfully launched.

This space allows graduates from all over the country to interact and enjoy dynamic and gamified activities, further strengthening ties and collaboration within the community.



**+13,000** users on the platform in 2023

### Scholarships with purpose

Thanks to the success of our donation campaign, we were able to award 100% scholarships to 66 new students through the “Scholarships with Purpose” program: a program that provides opportunities to talented people committed to their communities, who also have a deep sense of reciprocity and desire to help others.

5th anniversary of the Scholarships with Purpose program

**+430** scholarships

**+70,000** hours of positive social impact generated through its leadership projects.

In addition,

**27** scholarships were awarded to students of the Master’s Degree in Positive Education, thanks to a donation from FEMSA.

## INSTITUTE OF WELLNESS SCIENCES

This year, in collaboration with AMEDIRH and Forbes, the second call for the “Wellbeing Factor 2023” certification was launched, aimed at companies committed to wellbeing.

**65** companies participated

**40** certified

### Wellbeing 360: Positive Organizations

This global event took place on October 26 and 27 in a hybrid manner at the Citibanamex Center in CDMX and was broadcast in real time on the Wellbeing360.tv platform. It presented a complete program that included conferences, panels, mindfulness practices and a new showroom dedicated to Digital Skilling and Wellbeing.

Distinguished keynote speakers participated, such as Vanessa King, Tom Rath, Daniel Granata, Maryangel García, among others.

**12,464**

online impacts from Wellbeing360

**+14,000**

new registrations on the Wellbeing360.tv platform

**384**

in-person attendees

10,000

attendees at the virtual event

+5M

reach on social media



### Comprehensive Wellbeing

This year, an assessment instrument was successfully tested on +500 students, preparing for its massive deployment by 2024. It was highlighted at the 2023 NASPA Congress with a mental health care model and at the 1st National Summit of Health Talent Trainers , with Tecmilenio being the only non-medical university invited. The Wellbeing network offered more than 27,000 services to approximately 19,000 users of all levels.

### Saint Lucia International Festival

This year, the ICBI participated in the Santa Lucía International Festival, in Monterrey, where it gave five conferences related to Wellbeing 360 and 18 executions of Positive Museums.

**Positive Museums, since 2017 has positively impacted:**

+300,000

people with the promotion of comprehensive wellbeing and happiness in the community.



### INCLUSION OFFICE

Initiatives focused on inclusion in the workplace were developed based on the guidelines of the Tecnológico de Monterrey, to guarantee equal opportunities in this area. As part of this, training was provided in the action protocol for the prevention and attention of gender violence and topics of diversity, equity and inclusion, on all campuses.

Important agreements were signed with the UNHCR for workplace and educational inclusion projects for refugees, and with institutions in Guadalajara and Nuevo León to promote gender equality and raise awareness about gender violence, benefiting students and collaborators.



# Our Organization

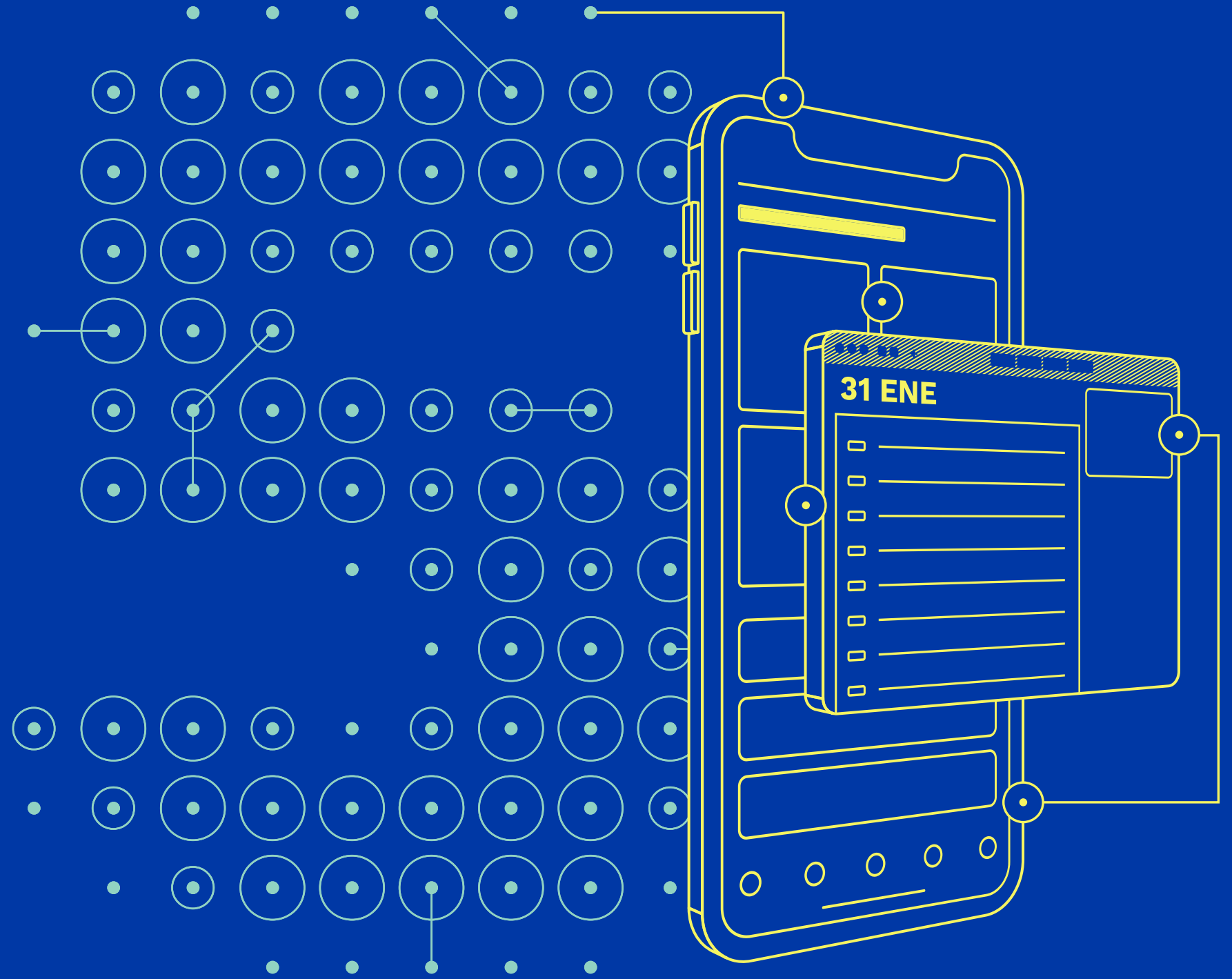



# Institutional culture, our essence as an institution

Culture is our way of being and acting as an institution. In the last 2 years, various diagnoses were carried out, which offered a more complete and current photograph of the culture that characterizes us today and the one that we need to model to meet the objectives for 2030.

What distinguishes us most is the high commitment, the sense of pride and belonging, the importance of transcendence and connection with the purpose of the Institution, as well as the high level of excellence. To strengthen it, it is necessary to continue working on recognition and further encourage collaboration, as well as create conditions to increase the wellbeing of collaborators, with more inclusive environments and leadership that accompanies, empowers and boost self-development in their teams, in addition to learn from mistakes and prioritize initiatives.

To strengthen this culture, it is necessary to recognize it, communicate it and live it in all our initiatives; reframe our narrative and ensure we can project it to our Tec community and external audiences consistently.

First Human Flourishing Report:



Environment to flourish:



## HUMAN FLOURISHING

Human flourishing is a path of personal and conscious growth in various areas to create a positive impact on the community and the planet. Our motto is “better person, better community, better planet.”

- **First Human Flourishing Report**, where we highlighted the achievements, findings and advances in the promotion of HF in our Institution.
- Creation of the “**Entorno para Florecer**” site on tec.mx, which contains resources and content for the Tec community and external audiences, that contribute to the personal and development process for the flourishing of each person.
- **FH in Latin America**: Tec leads a unique research project funded by the Templeton World Charity Foundation, which will map leaders and researchers in the FH knowledge areas in Latin America.

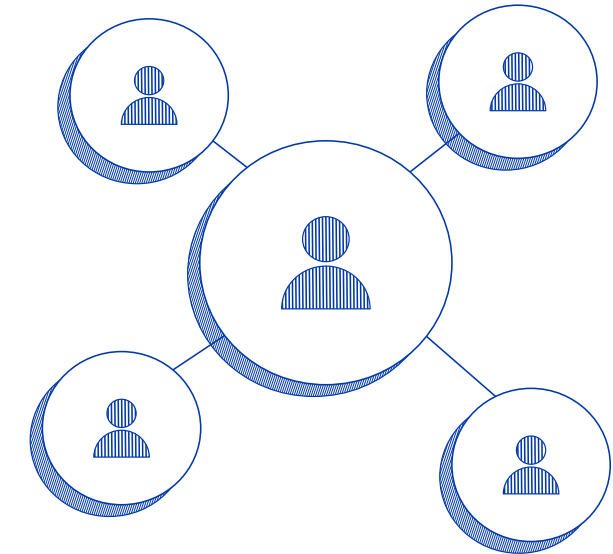

## TALENT THAT EXPANDS KNOWLEDGE

What defines Tec de Monterrey is the conviction that, as Eugenio Garza Sada said, “education can do everything.” This conviction is nourished by the passion, pride and work of those who have gone before us. The Institution is strengthened by attracting, developing and flourishing extraordinary talent.

The talent of the Tec de Monterrey community is key to expanding knowledge, consolidating academic excellence and strengthening our social commitment.

## Our collaborators

The Tecnológico de Monterrey is comprised of:

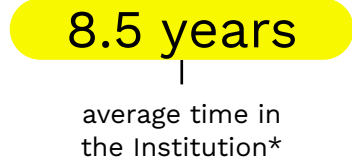
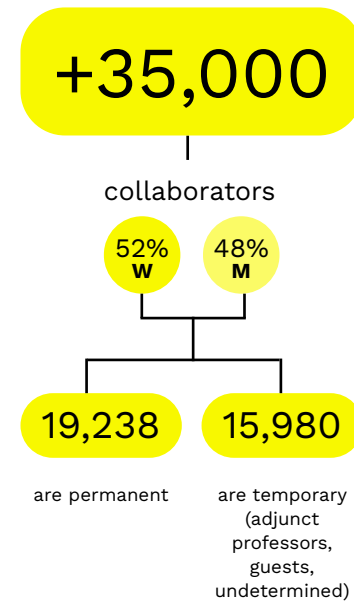

\*Average time in the institution does not include adjunct professors

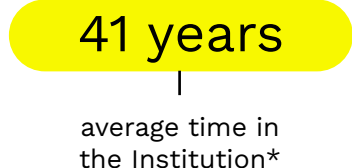

\*Average time in the institution does not include adjunct professors

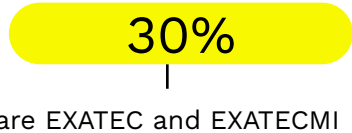

### Distribution by time in the Institution:

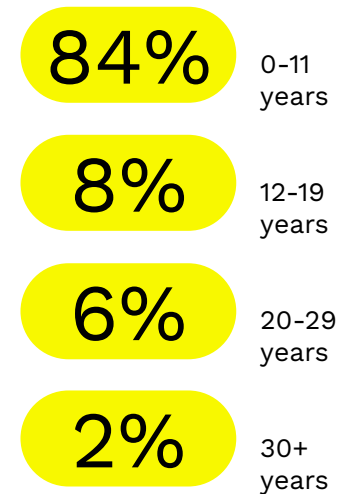

### Distribución por edades:

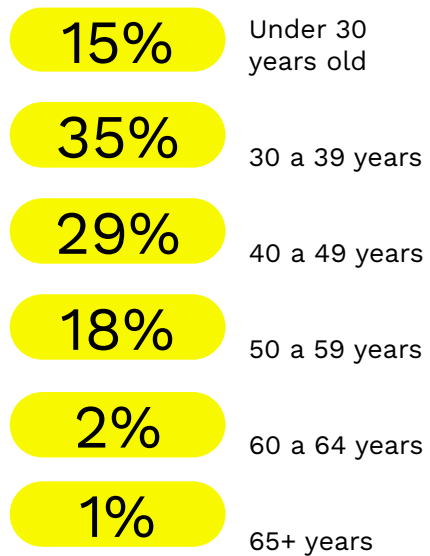

## Growth opportunities

It was possible to reach the goal for 2025 of having 30% of women in directive roles.

A new goal will be defined to reduce the wage gap at 2023

### The growth of women in leadership roles behaved as follows:

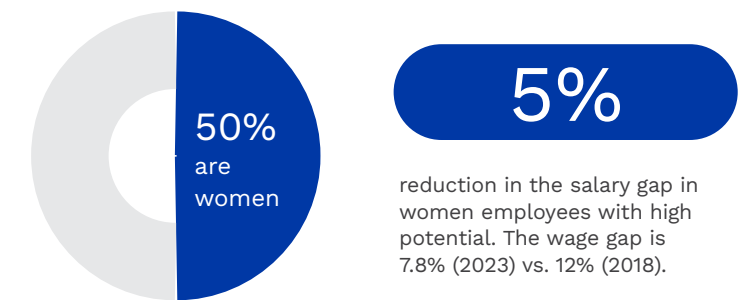
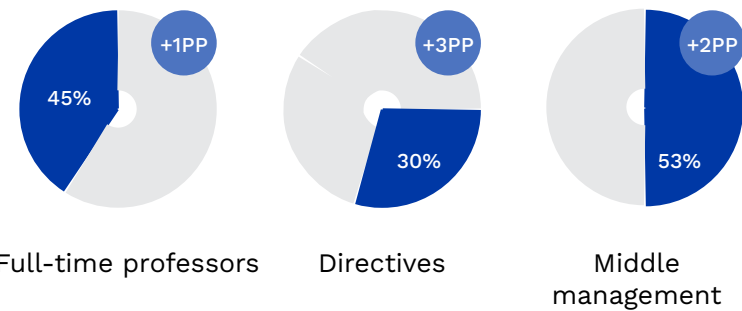

## Community Belonging

This year, we encouraged more moments of recognition and coexistence between collaborators.

### Family day

**54** events

**+29,500** attendees

**+400** entrepreneurs participated in the street market

### Loyalty

**+3,500** people recognized in all institutions

**54** ceremonies performed



**EDUARDO PÉREZ**  
45 years, Monterrey Campus



**JOSÉ LUIS FIGUEROA**  
55 years, Monterrey Campus



**FAWAZ BEDER**  
45 years, Laguna Campus



**SERGIO MARTÍNEZ**  
45 years, Puebla Campus



**GREGORIO VÁZQUEZ †**  
45 years, Monterrey Campus



**TERESA ALMAGUER**  
45 years, Monterrey Campus

### Organizational climate

This year, we boosted actions defined by a group of 400 members of the Institution, focused on issues of development, wellbeing and initiatives to build better leadership, all derived from the results of the survey applied in 2022 on organizational climate (Q12 Gallup) in which the level of commitment of the institution's collaborators and professors was measured and in which participated:

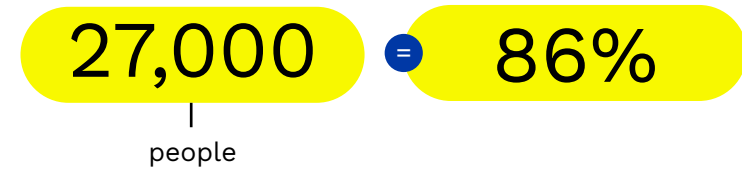

The results reflect that what they value most is having clarity of what is expected of them, being proud of the purpose of the Institution and having the opportunity to perform in what they do best. It was also detected that we must continue working to promote development, recognition, and continue showing genuine interest in them.

For this reason, during the second semester, we promoted actions, which were defined by a group of 400 members of the institution, focused on issues of development, wellbeing and initiatives to build better leadership.

### TECservices

Tec de Monterrey evolved the service model to offer solutions from the first contact to improve efficiency and the experience with the service.

The service team has resolved the needs of more than 250,000 users. In this process, we encouraged the use of TECbot, the virtual agent of TECservices, where more than 50,000 requests were managed.

In Market TEC, the payment of tuition and educational loans was integrated, where more than 150 thousand payment orders were processed. With the automated service of my student records, more than 70 thousand documents were generated, creating a saving of more than 17 thousand hours of work.

### TECgpt

This year we presented our own generative artificial intelligence model TECgpt, which is already being used by 500 professors and collaborators in beta mode; **being the first in Latin America to achieve it.**

TECgpt seeks to offer the Tec community the functions of AI application tools and models, such as: obtaining information through dialogue, about some procedures of the Institution, generating images, dynamics and exercises for classes, among others, in a secure technology ecosystem.

## LEADERSHIP IN DIVERSITY AND INCLUSION

In order to continue promoting the human dignity of those who belong to Tecnológico de Monterrey to be recognized and respected, we continued to generate actions that contribute to creating the necessary conditions for this.



We participated in the National Professors Reunion in the Human Dignity track, impacting 762 professors.

**We designed a module on topics of human dignity, diversity and inclusion** for the mothers and fathers diploma course “Families that transform.”

In total, this year the human dignity awareness courses have concluded:





## Safe community and gender equality

Tec de Monterrey signed an alliance with UN Women to implement for the first time in Mexico the “Safe Campuses for the Prevention of Gender Violence” program. With this, it became the first university in the world to join this effort.

The objective of this alliance is to promote gender equality and the prevention of gender violence within the Tec community. This project contributes to the goals set out in the 2021-2025 Equality Plan (PLIG, in Spanish).



For the fourth consecutive year, the Transparency Report was published, which makes visible the actions around gender violence and also provides an overview of the reports received during the year.

For the third time, we collaborated with the UN and its Global Pact agency, in training more than 35 companies on issues of gender perspective, equality and prevention of gender violence and discrimination. Thus, we contributed to Sustainable Development Goal 5 to build more egalitarian companies free of violence for women.

## Eleventh edition of the Tec Woman Award

This award, which aims to recognize and make visible the contributions, talent and career of women from the Tecnológico de Monterrey community and its institutions, had in 2023:



187

unique applications

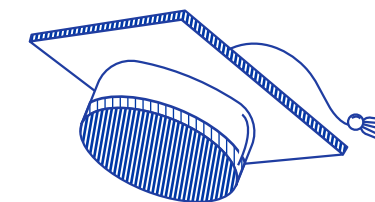

54

alumni

46

collaborators or directors

46

full-time or adjunct professors



41

students

17

winners

If you want to read more about the winners of this award, please go to the official website here:



7

full-time or adjunct professors

5

students

3

collaborators or directors

2

alumni

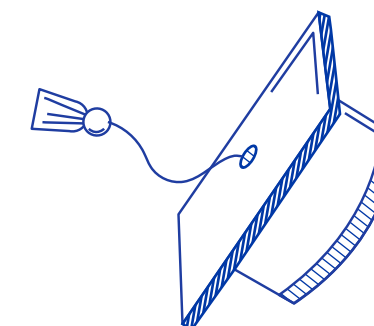



# SUSTAINABILITY TO TRANSFORM THE WORLD

Blue Route is the Sustainability and Climate Change Plan for 2025 of Tec de Monterrey. Its objective is to build a sustainable future by adopting a proactive culture in the face of the climate emergency, which is reflected in mitigation, adaptation, education, research and linkage actions to be a model Institution of sustainability.



## Goodbye to single-use plastics

We announced the commitment to significantly reduce single-use plastics, including the offer of water in plastic bottles and the use of disposables at events and cafeterias operated by Tec.

To achieve this, 231 drinking fountains were installed in 6 campuses, the TecFood2Go circular system was launched

on Monterrey, Querétaro and Guadalajara campuses, and the Sustainable Events Guide was deployed at the institution's flagship events, managing to avoid +147,000 bottles.

To learn more details about Blue Route, access its Achievements and Progress report here:



## THE Impact Ranking 2023

Evaluate the progress of universities with respect to the UN Sustainable Development Goals, Tecnológico de Monterrey placed itself in:



## STARS

Tec joined STARS (Sustainability Tracking, Assessment and Rating System), which will evaluate and measure progress in sustainability at 10 campuses in 6 categories, including academia, operation and linkage.



## Main achievements in the Blue Route axes

**Culture.** The first measurement of the Sustainability Culture Index was carried out, which allows us to know the attitudes, behaviors, ideologies and knowledge of the Tec community, obtaining a result of 66.5/100. This index will measure the evolution of the culture of sustainability in the Tec community.

**Mitigation.** It was achieved that 74% of the energy consumed by Tec de Monterrey and TecSalud comes from renewable sources in 2023. A 47% reduction in greenhouse gas emissions and a 27% reduction in total water consumption was also obtained in the campuses, both compared to 2019.

**Adaptation.** Climate Risk and Vulnerability Diagnosis workshops were held, with more than 90 participants from ProTec, the VP of Integrity and Compliance, physical plant and operational services. As a result, 100% of campuses have a climate risk analysis document and current vulnerability to climate change.

**Education.** It was ensured that as of August 2023, all Tec21 study plans, of all National Schools, contain at least 1 mandatory educational unit with content related to climate change.

**Research.** The first call for Applied Research and Innovation was launched, aimed at internal research professors to find, in collaboration with operational staff, solutions to the challenges of water, waste and sustainable mobility on the Tec campuses.

**Linkage.** Tec participated in COP28 in Dubai, where it connected with Latin American universities and EXATEC that attended. On the other hand, Blue Route received a fund of \$10,000 USD by Second Nature, to promote the creation of an interuniversity network for climate change.

# Institutional Government

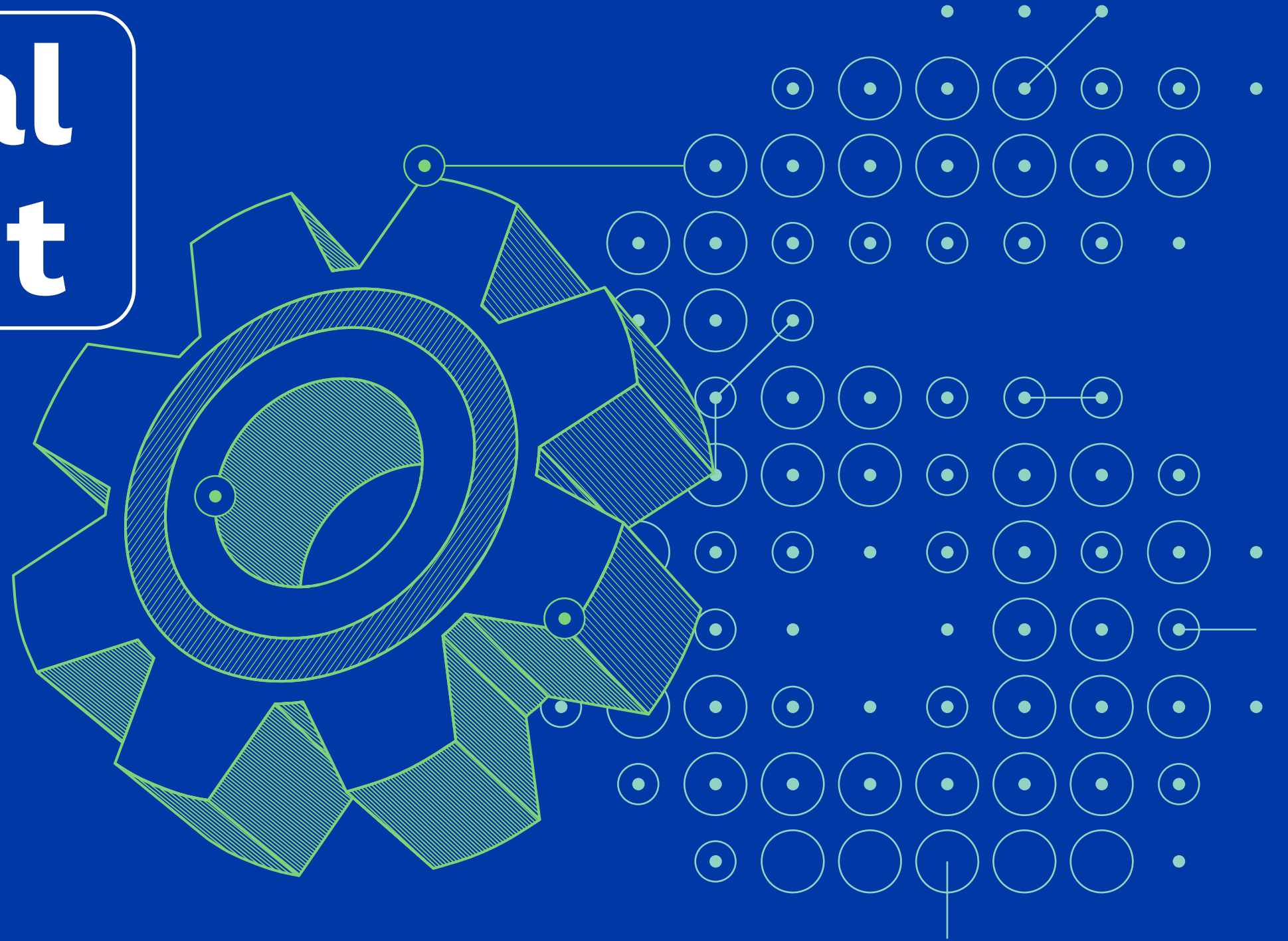



# Institutional Government

This year highlights the work carried out to achieve stable governance capable of addressing future issues, which is why, as part of the succession plans within our governing bodies, **new Presidents of the Councils and Contributing Committees and Campus Councils were appointed:** José Arturo Zapata Guizar, President of the Council of the Tecmilenio University; Alfonso Garza Garza, President of the Talent Committee; Helmut Fernando Huber Herrera, President of the Querétaro Campus Council; Luis Contreras Olavarrieta, President of the Puebla Campus Council; José Francisco Monroy Carrillo, President of the Toluca Campus Council and Eduardo Osuna Osuna, President of the Mexico City Council.

## ANNUAL ASSEMBLY 2023

The Annual General Assembly of the Board was held on February 20, 2023 in the Sala Mayor of the Rectoría, in person, and with the participation of Active, Honorary and Benefactor Associates, the Leadership Team and, for the first time, Presidents of Campus Councils and special guests.

**This edition highlighted the appointment of Ricardo Ernesto Saldivar Escajadillo as the fifth President of the Board of Trustees and new President of the Institutional Governance Committee in the 80 years of the institution, as well as the farewell of José Antonio Fernández Carbajal from these roles, who headed the Board of Trustees of Tecnológico de Monterrey for 11 years and will continue in his role as a member of said body. Likewise, the integration of two new members to the Board of Trustees, Eduardo Garza T. Junco and Rafael Reif, was announced.**



# ASSEMBLY AND BOARD OF TRUSTEES MEETING

## Board of Trustees Meeting 2023

The Annual Board of Trustees Meeting was held on **February 19, 20 and 21, 2023**, in which there was dialogue about the transformation of the technological, social, economic and environmental future, highlighting a reflection on the best way to build legacies that transcend.

There were also the presence of personalities who shared their vision of how to transform the future.

Voices of enormous global relevance participated, such as **Katharine Wilkinson**, writer and environmentalist; **Peter Leyden**, futurist and technology expert; **Fareed Zakaria**, CNN anchor and best-selling author; and **Rafael Reif**, 17th President of the Massachusetts Institute of Technology (MIT).

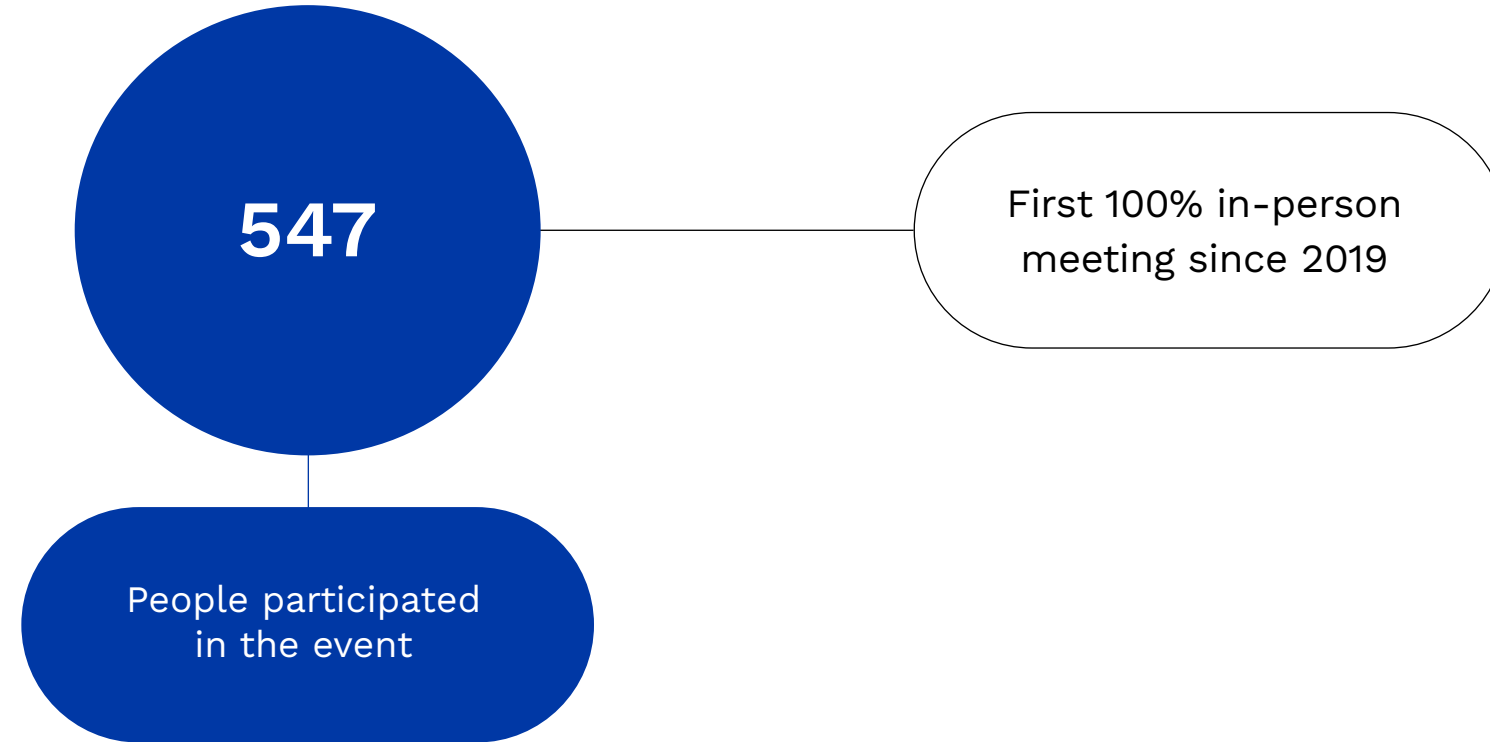

Katharine Wilkinson



Peter Leyden



Fareed Zakaria



Rafael Reif



## STRUCTURE OF THE GOVERNING BODIES OF ITESM, EISAC, AND ITESMAC 2023

**Board Assembly**

**Contributing Councils and Committees**

**Councils and Directors of the Campuses**

**Councils and Directors of the National Schools**

**Advisory Council and Subcommittees**

## BOARD ASSEMBLY OF ITESM, EISAC, AND ITESMAC IN 2023

### Active Board Members

Adrián Marengo Olavarrieta  
 Alberto Federico Terrazas Seyffert  
 Alberto Santos Boesch  
 Alejandra Clariond Rangel  
 Alfonso Garza Garza  
 Antonio Elosúa González (Leave of absence)  
 Armando Garza Sada  
 Bárbara Garza Lagüera Gonda  
 Bernardo Elosúa Robles  
 Bernardo Garza de la Fuente  
 Bertha Paula Michel González  
 Blanca Avelina Treviño de Vega  
 Carlos Salazar Lomelín  
 César Augusto Montemayor Zambrano  
 David Alejandro Garza Salazar  
 Diego Eugenio Calderón Rojas  
 Edna Camelia Jaime Treviño (Leave of absence)  
 Eduardo Garza T. Junco  
 Enrique de Jesús Zambrano Benítez  
 Ernesto Torres Cantú  
 Eugenio Rafael Garza Herrera  
 Eva María Garza Lagüera Gonda  
 Fernando Javier Amarante Zertuche  
 Francisco Javier Fernández Carbajal  
 Francisco Xavier Toussaint Elosúa  
 Francisco Zambrano Rodríguez  
 Gabriel Chapa Muñoz  
 Jorge Horacio Mazón Rubio  
 José Antonio Fernández Carbajal  
 José Arturo Zapata Guizar  
 José Gerardo Robinson Bours Castelo  
 José Germán Coppel Luken  
 José Medina Mora Icaza (Leave of absence)

Juan Carlos López Villarreal  
 Lorenzo Barrera Segovia  
 Manuel Fernando Sescosse Varela  
 Marcus Federico Baur Neuburger  
 Mariana Garza Lagüera Gonda  
 Mario Orozco Arena  
 Miguel Eduardo Padilla Silva  
 Myriam Guadalupe de la Vega Arizpe  
 Ricardo Ernesto Saldívar Escajadillo  
 Ricardo Martín Bringas  
 Roberto Villarreal Maiz  
 Rogelio de los Santos Calderón  
 Rogelio Zambrano Lozano  
 Salvador Alva Gómez  
 Tomás Milmo Santos

### Honoree Board Members

Alejandro Garza Lagüera †  
 Alfonso González Migoya  
 David Noel Ramírez Padilla  
 Eduardo Garza T. Fernández  
 Eugenio Clariond Reyes Retana  
 Fernando Elizondo Barragán  
 Javier Arroyo Chávez  
 José Gonzalo Mitre Salazar †  
 Juan Gerardo Garza Treviño  
 Luis Lauro Cantú Salinas  
 Manuel de la Garza Robertson †  
 Miguel Otto Schwarz Marx  
 Othón Ruiz Montemayor †  
 Rafael Rangel Sostmann  
 Ricardo Guajardo Touché

\*cruz: Consejero fallecido durante 2023

### Board of Trustees of Fundación Santos y De La Garza Evia I. B. P.

Ricardo Ernesto Saldívar Escajadillo (President)  
 Alfonso Garza Garza  
 David Alejandro Garza Salazar  
 Enrique de Jesús Zambrano Benítez  
 Eugenio Rafael Garza Herrera  
 Eva María Garza Lagüera Gonda  
 Guillermo Torre Amione  
 José Antonio Fernández Carbajal  
 Mariana Garza Lagüera Gonda  
 Rogelio Zambrano Lozano  
 Hugo Armando Garza Medina (Secretary)

### Benefactor Board Members

Consuelo Garza Lagüera de Garza Valdés  
 David Garza Lagüera  
 Jorge Samuel Ritz Habermann  
 Susana Canales Clariond  
 Tomás González Sada

## Board of Trustees

- Ricardo Ernesto Saldívar Escajadillo (President)
- Alfonso Garza Garza
- Armando Garza Sada
- Blanca Avelina Treviño de Vega
- César Augusto Montemayor Zambrano
- David Alejandro Garza Salazar
- Edna Camelia Jaime Treviño (Leave of absence)
- Eduardo Garza T. Junco
- Enrique de Jesús Zambrano Benítez
- Eugenio Rafael Garza Herrera
- Eva María Garza Lagüera Gonda
- José Antonio Fernández Carbajal
- José Arturo Zapata Guizar
- José Germán Coppel Luken
- Rafael Reif
- Lorenzo Barrera Segovia
- Marcus Federico Baur Neuburger
- Mariana Garza Lagüera Gonda
- Rogelio Zambrano Lozano
- Tomás Milmo Santos
- Hugo Armando Garza Medina (Secretary)
- Carlos Eduardo Alderete Ancira (Alternate non-member Secretary)



## Leadership Team

**David Garza Salazar**  
President of Tecnológico de Monterrey

**Juan Pablo Murra Lascurain**  
Rector for Higher Education of Tecnológico de Monterrey

**Victor Eduardo Gutiérrez Aladro**  
Rector of Operations of Tecnológico de Monterrey

**Guillermo Torre Amione**  
Rector of TecSalud and Vice-President of Research

**Bruno Felipe Zepeda Blouin**  
Rector of Tecmilenio University

**Miguel Valle Herrera**  
Vice-President of Administration and Finance

**Carles Abarca**  
Vice-President of Digital Transformation

**Inés Sáenz Negrete**  
Vice-President of Inclusion, Social Impact, and Sustainability

**Hugo Armando Garza Medina**  
Vice-President of Strategy

**Alejandro Alfonso Poiré**  
Vice-President of Projection and Liaison

**Hernán García González**  
Vice-President of TecVentures

**Paulina Campos Villaseñor**  
Chief Compliance and Risk Officer



## CONTRIBUTING COUNCILS AND COMMITTEES

### Audit and Risk Management Committee

César Augusto Montemayor Zambrano (President)  
Eduardo Mellado Flores  
Francisco Zambrano Rodríguez  
Jorge de Jesús Elizundia Balcázar  
José González Ornelas  
Oscar Eduardo Rocha Dabrowski  
Víctor Manuel Romo Muñoz  
Paulina Campos Villaseñor (Secretary)

### Talent Committee

Alfonso Garza Garza (President)  
Adela Giral López  
Alejandro Arturo Kipper Lezama  
David Alejandro Garza Salazar  
Eduardo Bernabé de la Garza Zamarrón  
Kelly Lee Kroger  
Eric Pascual (Secretary)

### Development Committee

Eugenio Rafael Garza Herrera (President)  
Alberto Santos Boesch  
David Alejandro Garza Salazar  
David Noel Ramírez Padilla  
Ismael Rodríguez Durán  
Lorena Fabiola Guillé Laris  
Susana Coppel García  
Alejandro Alfonso Poiré Romero (Secretary)

### distritotec Committee

Eva María Garza Lagüera Gonda (President)  
Arnulfo Treviño Garza  
David Alejandro Garza Salazar  
Francisco Xavier Toussaint Elosúa  
Juan Ernesto Pardinás Carpizo  
Lorenza Martínez Trigueros  
Patricio Garza Garza  
Mario Adrián Flores Castro (Secretary)

### Finance and Investment Committee

Lorenzo Barrera Segovia (President)  
Antonio Elosúa González (Leave of absence)  
David Alejandro Garza Salazar  
Francisco Xavier Toussaint Elosúa  
Javier Gerardo Astaburuaga Sanjines  
José Carlos Pons de la Garza  
María de la Luz Calvet Roquero  
Valeria Strappa  
Miguel Valle Herrera (Secretary)

### Institutional Government Committee

Ricardo Ernesto Saldívar Escajadillo (President)  
Alfonso Garza Garza  
Enrique de Jesús Zambrano Benítez  
Eugenio Rafael Garza Herrera  
José Antonio Fernández Carbajal  
Hugo Armando Garza Medina (Secretary)

### Academic and Research Council

Rogelio Zambrano Lozano (President)  
Armando Garza Sada (Leave of absence)  
Carlos Salazar Lomelín  
Carmen Junco de la Vega González  
David Alejandro Garza Salazar  
Francisco Javier Fernández Carbajal  
Gabriel Sod Hoffs  
Gilberto Leonardo Rodríguez Martínez  
Leopoldo Cedillo Villarreal  
Mariana Garza Lagüera Gonda  
Juan Pablo Murra Lascurain (Secretary)

### TecSalud Council

Tomás Milmo Santos (President)  
Alejandra Clariond Rangel  
Bernardo Garza de la Fuente  
David Alejandro Garza Salazar  
Ian Armstrong Zambrano  
José Germán Coppel Luken  
Vicente Valero Castillo  
Guillermo Torre Amione (Secretary)

### TecSalud University Council

José Arturo Zapata Guizar (President)  
Blanca Avelina Treviño de Vega  
César Augusto Montemayor Zambrano  
David Alejandro Garza Salazar  
Fernando Angel González Olivieri  
José Antonio Fernández Garza Lagüera  
Miguel Eduardo Padilla Silva  
Roland Loehner Niebuhr  
Salvador Alva Gómez  
Simón Cohen Shamosh  
Bruno Felipe Zepeda Blouin (Secretary)

## COUNCILS AND CAMPUS DIRECTORS

### Aguascalientes Campus

Oscar Humberto Lomelín Ibarra  
Chairman of the Council

Roberto Soto Soto  
Campus Director

### Chiapas Campus

José Luis Mandiola Totoricagüena  
Chairman of the Council

Manuel de Jesús Villalobos  
Campus Director

### Chihuahua Campus

Alberto Federico Terrazas Seyffert  
Chairman of the Council

Armando Bahena Vigna  
Campus Director

### Mexico City Region

Eduardo Osuna Osuna  
Chairman of the Council

Rashid Abella Yunes  
Vice-President of the Region and  
Mexico City Campus Director

Verónica Pedrero Padilla  
Estado de México Campus Director

Karla Jeanire Vargas Díaz  
Santa Fe Campus Director

### Ciudad Juárez Campus

Jorge Luis Contreras Fornelli  
Chairman of the Council

Judith Marcela Soto  
Directora de Campus

### Ciudad Obregón Campus

José Gerardo Robinson Bours Castelo  
Chairman of the Council

Baltazar Ernesto Alvarado Zamora  
Campus Director

### Colima Campus

Emilio Brun Solórzano  
Chairman of the Council

Guillermina Díaz Gómez  
High School Director

### Cuernavaca Campus

Jens Hagedorn Hermann  
Chairman of the Council

José Antonio Moya Peredo  
Campus Director

### Guadalajara Campus

María Isabel Lazo Corvera  
Chairman of the Council

Claudia Félix Sandoval  
Vice-President of the Occident Region  
and Guadalajara Campus Director

### Hidalgo Campus

Romualdo Tellería Beltrán  
Chairman of the Council

Octavio Díaz Barriga Guizar  
Campus Director

### Irapuato Campus

Salvador Cayón Ceballos  
Chairman of the Council

Luis Miguel Villarreal  
Campus Director

### Laguna Campus

Alberto Francisco Allegre Del Cueto  
Chairman of the Council

Eduardo Arrambide Leal  
Campus Director

### León Campus

Mario Orozco Arena  
Chairman of the Council

Juan Carlos Arreola Rivas  
Campus Director

### Morelia Campus

Eduardo Ramírez Díaz  
Chairman of the Council

Randall Gregory Jesus Coffie  
Campus Director

### Puebla Campus

Luis Contreras Olavarrieta  
Chairman of the Council

Jorge Francisco Rocha Orozco  
Campus Director

### Querétaro Campus

Helmut Fernando Huber Herrera  
Chairman of the Council

Pascual Alcocer Alcocer  
Campus Director

### Saltillo Campus

Juan Carlos López Villarreal  
Chairman of the Council

Adrián Fernando González Zambrano  
Campus Director

### Sinaloa Campus

Jorge Samuel Ritz Habermann  
Chairman of the Council

Richard David Huett  
Campus Director

### San Luis Potosí Campus

Miguel Hidalgo Olvera  
Chairman of the Council

Marco Edgar Vargas Herrada  
Campus Director

### Sonora Norte Campus

Jorge Horacio Mazón Rubio  
Chairman of the Council

Lucía Guadalupe Canseco Campoy  
Campus Director

### Tampico Campus

Rafael Gerardo González Acuña  
Chairman of the Council

Oscar Alfonso Flores Cano  
Campus Director

### Toluca Campus

José Francisco Monroy Carrillo  
Chairman of the Council

Claudia Gallegos Cesaretti  
Directora de Campus

### Zacatecas Campus

Pablo Yaco Reimers Campos  
Chairman of the Council

Alfredo de Alba  
Campus Director

## COUNCILS AND DIRECTORS OF THE NATIONAL SCHOOLS



### School of Architecture, Art and Design

Gilberto Leonardo Rodríguez Martínez  
Chairman of the Council

Roberto Iñiguez Flores  
National Dean

### School of Social Sciences and Government

Gabriel Sod Hoffs  
Chairman of the Council

Edna Camelia Jaime Treviño  
National Dean

### School of Humanities and Education

Carmen Junco de la Vega González  
Presidenta de Consejo

Judith Aurora Ruíz Godoy  
National Dean

### School of Engineering and Sciences

Leopoldo Cedillo Villarreal  
Chairman of the Council

Feniosky Avelhermi Pena-Mora  
National Dean

### School of Business

Carlos Salazar Lomelín  
Chairman of the Council

María Elena Vazquez  
National Dean

Horacio Arredondo Villalba  
EGADE Business School Dean

### School of Medicine and Health Sciences

Tomás Milmo Santos  
Chairman of the Council TecSalud

Luis Alonso Herrera  
National Dean

## ADVISORY COUNCIL AND SUBCOMMITTEES

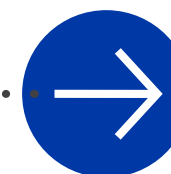

### Entrepreneurship Institute Eugenio Garza Lagüera

Rogelio de los Santos Calderón  
President

### Subcommittee of Financial Heritage - (Finances Committee)

Francisco Javier Fernández Carbajal  
President

### Subcommittee of Real State Heritage - (Finances Committee)

Francisco Xavier Toussaint Elosúa  
President



# Appendices

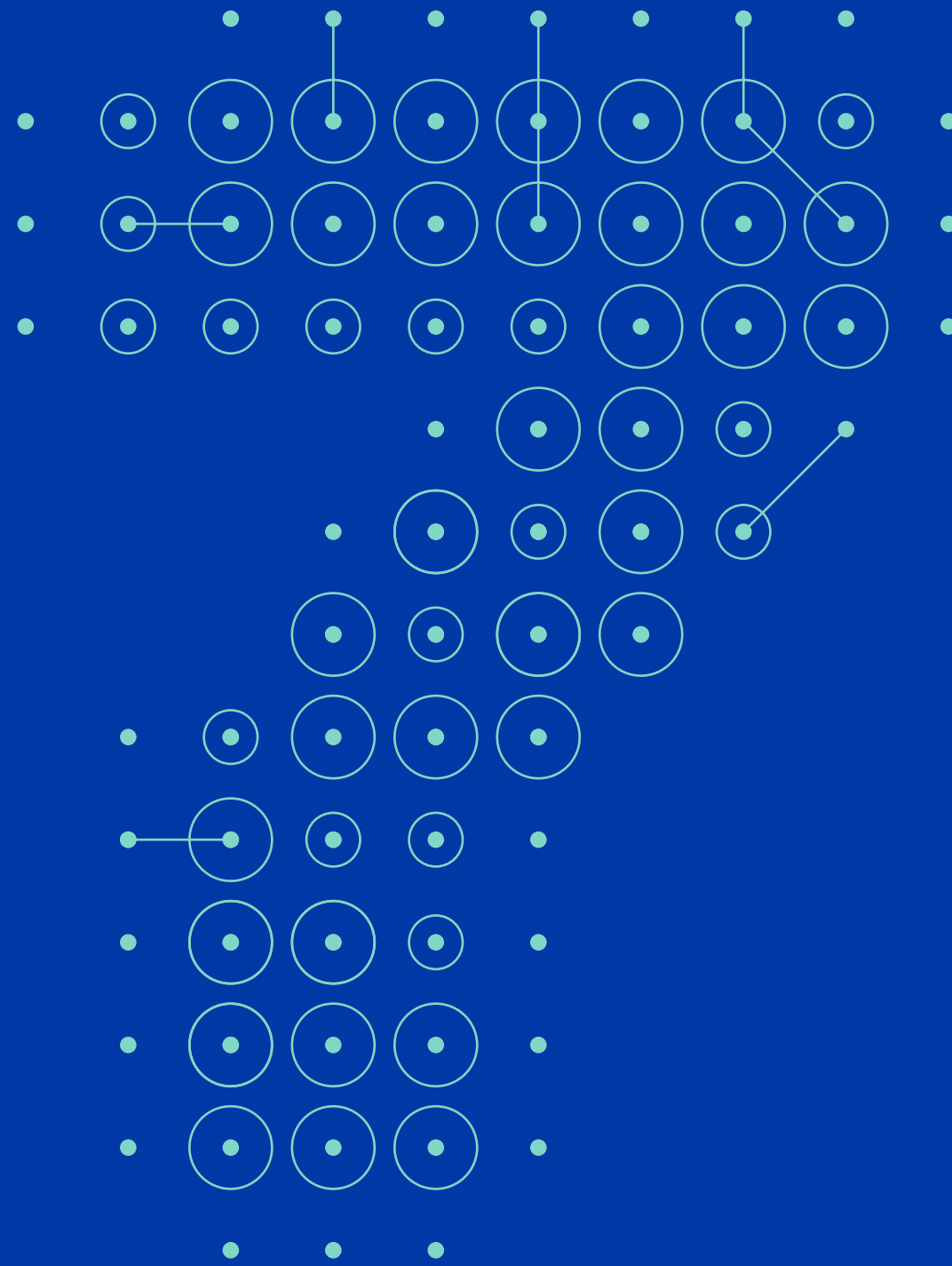

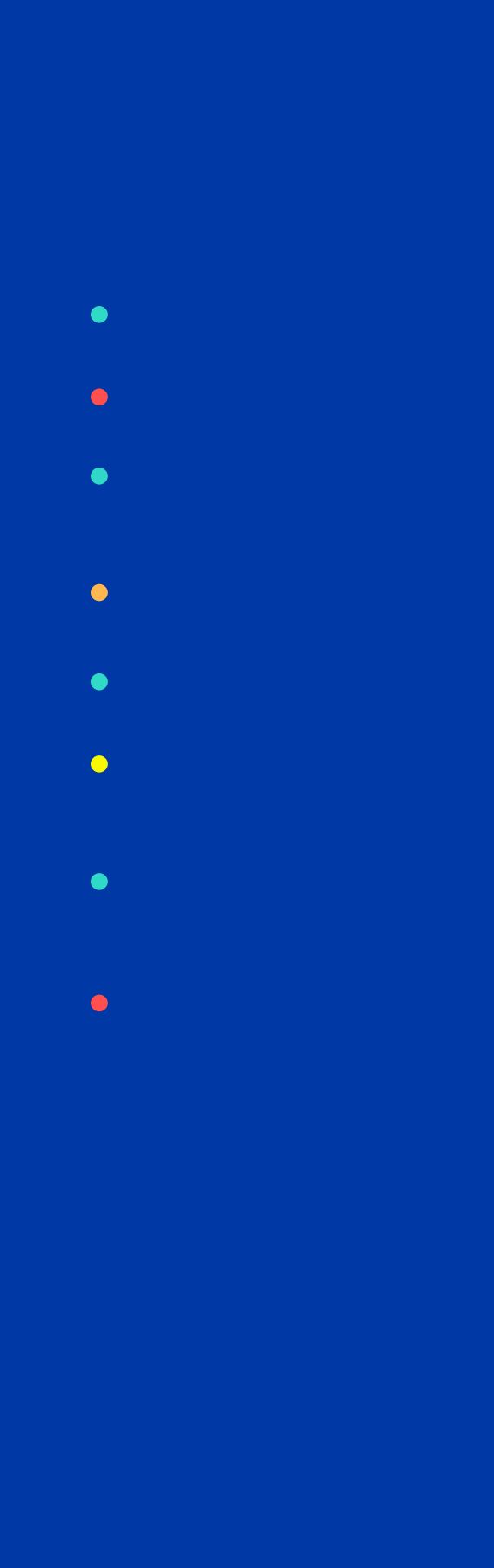







## ACADEMIC PROGRAMS

### High School

Multicultural  
Bicultural  
International

### Undergraduate

Business

- LCPF B.A. in Finance and Accounting
- LDO B.A. in Human Resource Management
- LDE B.A. in Entrepreneurship
- BBA B.A. in Business Administration
- BFI B.A. in Financial Management
- LIT B.A. in Business Intelligence
- LEM B.A. in Marketing
- BGB B.A. in International Business

Health

- LBC B.A. in Bioscience
- LNB B.A. in Nutrition and Wellness
- LPS B.S. in Clinical Psychology and Health
- MC Physician and Surgeon
- MO Medical and Surgical Dentist

Creative Studies

- ARQ B.A. in Architecture - Multi-entry
- LAD B.A. in Digital Art
- LC B.A. in Communication
- LDI B.A. in Design
- LEI B.A. in Educational Innovation
- LLE B.A. in Spanish Literature
- LPE B.A. in Journalism
- LTM B.A. in Music Technology and Production

Built Environment

- ARQ B.A. in Architecture - Multi-entry
- IC B.S. in Civil Engineering - Multi-entry
- LUB B.A. in Urbanism

Law, Economics and International Relations

- LED B.A. in Law
- LEC B.A. in Economics
- LTP B.A. in Governance and Public Transformation
- LRI B.A. in International Relations

Engineering and Science

#### INNOVATION AND TRANSFORMATION

- IMD B.S. in Biomedical Engineering
- IC B.S. in Civil Engineering - Multi-entry
- IE B.S. in Electronics Engineering
- BIE B.S. in Industrial Engineering with minor in Systems Engineering
- IID B.S. in Innovation and Development
- IM B.S. in Mechanical Engineering
- BME B.S. in Mechatronics Engineering

#### COMPUTING AND INFORMATION TECHNOLOGIES

- IRS B.S. in Robotics and Digital Systems
- ITC B.S. in Computer Science and Information Technologies
- ITD B.S. in Digital Transformation in Business

#### BIOENGINEERING AND CHEMICAL PROCESSES

- IAL B.S. in Food Engineering
- IAG B.S. in Agricultural Biosystems
- IBT B.S. in Biotechnology
- IDS B.S. in Sustainable Development Engineering
- IQ B.S. in Chemical Engineering

#### APPLIED SCIENCE

- IDM B.S. in Data Science and Engineering Mathematics
- IFI B.S. in Engineering Physics
- INA B.S. in Nanotechnology Engineering

### Graduate

EAAD

- MDU: Master in Urban Design and Architecture

EGADE

- DCA: Ph. D. in Business Administration
- DCF: Ph. D. in Financial Science
- MAF: Master in Finance
- MBA: Master in Business Administration
- MBD: Master in Business Analytics
- MBM: Master in Administration
- MDE: Executive Master in Business Administration
- MMT: Master in Marketing

EGTP

- DPP: Ph. D. in Public Policy
- MAP: Master in Public Administration
- MEK: Master in Applied Economics
- MGP: Master in Public Policy
- MGT: Master in Government and Public Transformation
- MPE: Master in Strategic Foresight

EHE

- DEE: Ph. D. in Educational Innovation
- DEH: Ph. D. in Humanistic Studies
- EEE: Specialization in Teaching and Assessment of English as a Second Language

- EGE: Specialization in Management for Educational Leadership and Innovation Online Modality
- MEE: Master in Education
- MEH: Master in Humanistics Studies
- MHD: Master in Digital Humanities
- MTO: Master in Education Entrepreneurship
- MTE: Master in Educational Technology

#### EIC

- DBT: Ph. D. in Biotechnology
- DCC: PH. D. in Computer Sciences
- DCI: Ph. D. in Engineering Sciences
- DNT: Ph. D. in Nanotechnology
- ELS: Specialization in Logistics and Supply Chain
- ENA: Specialization in Applied Artificial Intelligence
- EPY: Specialization in Project Management
- MBI: Master of Science in Biotechnology
- MCC: Master in Computer Science
- MCI: Master of Science in Engineering
- MCY: Master in Cybersecurity
- MEM: Master in Engineering Management
- MER: Master in Energy Management and Renewable Sources
- MID: Master in Innovation for Enterprise Development
- MIP: Master in Engineering with specialization in Quality Systems and Productivity
- MNA: Master in Applied Artificial Intelligence
- MNT: Master in Nanotechnology
- MSM: Master of Science in Manufacturing Systems
- MTI: Master in Information Technology Management

#### EMCS

- DBC: PH. D. in Biomedical Sciences
- DCL: Ph.D. in Clinical Sciences
- MBC: Master in Biomedical Sciences
- RAP: Residency in Anatomic Pathology
- RCA: Residency in Health Care Quality
- RCR: Residency in Cardiology

- REA: Residency in Anesthesiology
- REC: Residency in General Surgery
- REE: Residency in Critical Care Medicine
- REG: Residency in Obstetrics and Gynecology
- REM: Residency in Internal Medicine
- REN: Residency in Pediatrics
- REO: Residency in Ophthalmology
- RER: Residency in Radiology and Imaging
- REU: Residency in Neurology
- RGE: Residency in Geriatrics
- RNE: Residency in Neonatology
- RNP: Residency in Pediatric Neurology
- RPS: Residency in Psychiatry
- RUR: Residency in Urology

#### Business

- MGN: Master in Enterprise Administration Online

## GLOSSARY OF ACRONYMS

**AACSB:** Association to Advance Collegiate Schools of Business

**AAHCI:** Alliance of Academic Health Centers International

**ABET:** Accreditation Board for Engineering and Technology

**ACEJMC:** Association for Education in Journalism and Mass Communication

**ACNUR/UNHCR:** United Nations High Commissioner for Refugees

**AECID:** Spanish Agency for International Development Cooperation

**AHA:** American Heart Association

**AIB-LAC:** Academy of International Business, Latin America and the Caribbean Chapter

**AMBA:** Association of MBAs

**AMEDIRH:** Mexican Association in Human Resources Management

**AMFEM:** Mexican Association of Medical Schools

**ANCC:** American Nurse Credentialing Center

**APRU:** Association of Pacific Rim Universities

**ARQ:** Architecture

**ASCE:** American Society of Civil Engineers

**ASU:** Arizona State University

**BALAS:** Business Association of Latin American Studies

**B2B:** Business to business

**BID/IDB:** Inter-American Development Bank

**BIM:** Building Information Modeling

**BFI:** Bachelor in Finance

**CFC:** Center for the Future of Cities

**CAABI:** Academic Center for Comprehensive Wellbeing Care

**CADi:** Update Courses in the Discipline

**CEDDIE:** Center for Professor Development and Educational Innovation

**CeSI:** Comprehensive Health Center

**CIMA:** Know, Innovate, Measure and Act  
**CINDA:** Interuniversity Development Center  
**CNP:** National Graduate Congress  
**COE:** Centers of Excellence  
**COMAEM:** Mexican Council for the Accreditation of Medical Education AC  
**COMEPO:** Mexican Council of Graduate Studies  
**CONACYT:** National Council of Sciences and Technologies  
**CONAHCYT:** National Council of Humanities, Sciences and Technologies  
**CONL:** Council of Nuevo León  
**COPAES:** Council for the Accreditation of Higher Education  
**EAAD:** School of Architecture, Art and Design  
**EARNEST:** Equitable, Affordable and Resilient Nationwide Energy System Transition  
**ECSG:** School of Social Sciences and Government  
**ECMO:** Extracorporeal membrane oxygenation  
**ECSG:** School of Social Sciences and Government  
**EHE:** School of Humanities and Education  
**EIC:** School of Engineering and Sciences  
**EISAC:** Higher Education and Research AC  
**EMCS:** School of Medicine and Health Sciences  
**EN:** Business School  
**ELSO:** Extracorporeal Life Support  
**FAIR:** Center for Financial Access, Inclusion and Research  
**FETECMI:** Federation of TecMilenio Students at the national level  
**FIL:** International Book Fair  
**FIMPES:** Federation of Private Mexican Institutions of Higher Education  
**FMEI:** My International Experience Fund  
**FODECIJAL:** Scientific Development Fund of Jalisco  
**FRC:** FIRST Robotics Competition  
**FSGE:** Santos y de la Garza Evia Foundation  
**FSO:** Online Higher Education  
**FTC:** FIRST Tech Challenge  
**FWCI:** Field Weighted Citation Impact

**GEDC:** Global Engineering Deans Council  
**GPAI:** Global Alliance for Artificial Intelligence  
**GRASFI:** Global Research Alliance for Sustainable Finance and Investment  
**GSL:** Global Shared Learning  
**HIR:** Hall Immersive Room  
**IAA:** Applied Artificial Intelligence  
**IAMSM:** Institute of Advanced Materials for Sustainable Manufacturing  
**IAZ:** Agricultural Zootechnical Engineer  
**IBP:** Biochemical Engineer Food Processing Administrator  
**IC:** Civil Engineering  
**ICBI:** Institute of Integral Wellbeing Sciences  
**IFEM:** Institute of Business Families  
**IME:** Electrical Mechanical Engineering  
**IMPLAN:** Municipal Planning Institute  
**IMRF:** International Multidisciplinary Research Foundation  
**IOR:** Obesity Research Institute  
**IQ:** Chemical Engineering  
**ITDP:** Institute for Transportation and Development Policy  
**ITESM:** Instituto Tecnológico de Estudios Superiores de Monterrey  
**LAE:** Bachelor of Business Administration  
**LATAM:** Latin America  
**LCC:** Bachelor of Communication Sciences  
**LEC:** Bachelor's Degree in Economics  
**LiFE:** Leadership and Student Education  
**LIN:** Bachelor of International Business  
**MBA:** Master in Business Management  
**MIT:** Massachusetts Institute of Technology  
**NASPA:** National Association of Student Personnel Administrators Strategies  
**NISB:** Biological Systems Innovation Center  
**NPS:** Net Promoter Score  
**PET-CT:** Positron Emission Computed Tomography  
**PIN:** Professionalism and Innovation

**PRME:** Principles for Responsible Management Education  
**QS:** Quacquarelli Symonds  
**RECLA:** Continuing Education Network for Latin America and Europe  
**RISE:** Real Impact on Society and Environment Competition  
**RNP:** National Professors Reunion  
**SACSCOC:** Southern Association of Schools and Colleges Commission on Colleges  
**SADM:** Monterrey Water and Drainage Services  
**SAT:** Artistic Society of Tec  
**SDV:** Self Driving Vehicle  
**SIWI:** Stockholm International Water Institute  
**SMT:** Mexican Transplant Society  
**STEM:** Science, Technology, Engineering, Math  
**TOP:** Tecmilenio Positive Organization  
**URC:** University Rover Challenge  
**URSA:** Urban Reporting based on Satellite Analysis  
**USAID:** United States Agency for International Development  
**USF:** Urban Studies Foundation  
**UTSA:** The University of Texas at San Antonio  
**WEF:** World Engineering Education Forum  
**WEF & GEDC:** World Engineering Education Forum & Global Engineering Deans Council  
**WEF:** World Economic Forum  
**ZMM:** Monterrey Metropolitan Area